

CUSTOM-MADE
SUPPLY SPECIAL SIZES ACCORDING
TO CUSTOMER'S REQUEST

GRANITE SURFACE PLATES

**INSPECTION
CERTIFICATE**



6900-132

Grade 00

Code	Size (LxWxH)	Flatness	Weight	Max. load
6900-132*	300x200x60mm	2.7µm	11kg	30kg
6900-142*	400x250x60mm	2.9µm	18kg	50kg
6900-144*	400x400x60mm	3.1µm	29kg	60kg
6900-153*	500x315x70mm	3.2µm	33kg	60kg
6900-164*	630x400x80mm	3.5µm	60kg	65kg
6900-166*	630x630x100mm	3.8µm	119kg	75kg
6900-185*	800x500x100mm	3.9µm	120kg	100kg
6900-1106*	1000x630x140mm	4.4µm	265kg	200kg
6900-1101*	1000x1000x150mm	4.8µm	450kg	400kg
6900-1128*	1200x800x160mm	4.9µm	461kg	500kg
6900-1161*	1600x1000x180mm	5.8µm	864kg	600kg
6900-1201*	2000x1000x220mm	6.5µm	1320kg	650kg
6900-1202*	2000x1500x250mm	7.0µm	2250kg	750kg

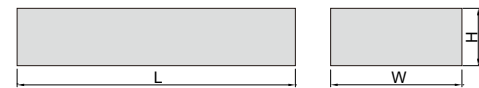

Grade 0

Code	Size (LxWxH)	Flatness	Weight	Max. load
6900-032*	300x200x60mm	5.4µm	11kg	60kg
6900-042*	400x250x60mm	5.9µm	18kg	100kg
6900-044*	400x400x60mm	6.3µm	29kg	120kg
6900-053*	500x315x70mm	6.4µm	33kg	120kg
6900-064*	630x400x80mm	7.0µm	60kg	130kg
6900-066*	630x630x100mm	7.6µm	119kg	150kg
6900-085*	800x500x100mm	7.8µm	120kg	200kg
6900-0106*	1000x630x140mm	8.7µm	265kg	400kg
6900-0101*	1000x1000x150mm	9.7µm	450kg	800kg
6900-0128*	1200x800x160mm	9.8µm	461kg	1000kg
6900-0161*	1600x1000x180mm	11.5µm	864kg	1200kg
6900-0201*	2000x1000x220mm	12.9µm	1320kg	1300kg
6900-0202*	2000x1500x250mm	14.0µm	2250kg	1500kg

*Supplied with manufacturer inspection certificate

- Made of granite, free from deterioration or dimensional change over time, minimal changes in dimension due to temperature changes
- Meet DIN876, grade 00 is for inspection room or lab, grade 0 is for workshop
- Optional accessory:
stand for granite surface plate (code 6902),
jack for granite surface plate (code 6903)

JACK SET FOR GRANITE SURFACE PLATES

- 5 jacks per set
- Adjustable height
- For large granite surface plates:
2000x1000x220mm
(code 6900-0201 and 6900-1201)
2000x1500x250mm
(code 6900-0202 and 6900-1202)

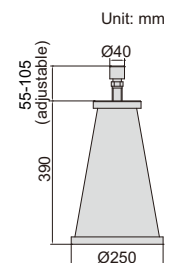

Code

6903-B

6903-B

STANDS FOR GRANITE SURFACE PLATES

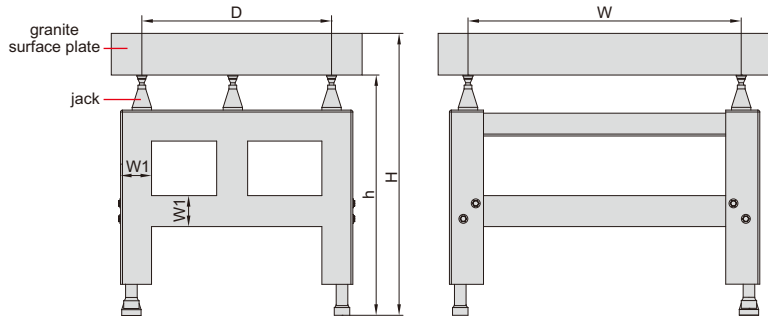
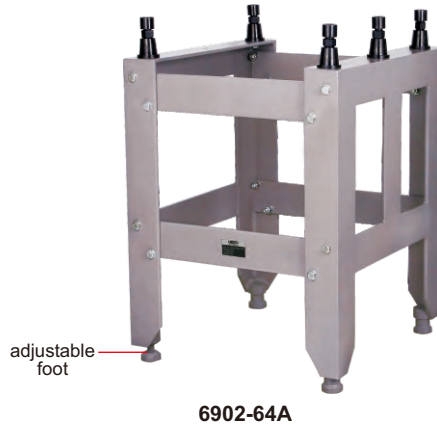

- For medium size granite surface plates
- 5 jacks are included
- Adjusting range of jacks: 25mm
- One foot on the bottom is adjustable

Low stands

Code	For granite surface plate	W	D	H (with granite surface plate)	h (without granite surface plate)	W1
6902-64A	630x400x80mm (code 6900-064 and 6900-164)	352	224	775-800	695-720	80
6902-66A	630x630x100mm (code 6900-066 and 6900-166)	352	352	775-800	675-700	80
6902-85A	800x500x100mm (code 6900-085 and 6900-185)	448	280	775-800	675-700	80
6902-106A	1000x630x140mm (code 6900-0106 and 6900-1106)	560	352	755-780	615-640	80
6902-101A	1000x1000x150mm (code 6900-0101 and 6900-1101)	560	560	755-780	605-630	80
6902-128A	1200x800x160mm (code 6900-0128 and 6900-1128)	672	448	755-780	595-620	80
6902-161A	1600x1000x180mm (code 6900-0161 and 6900-1161)	896	560	755-780	575-600	80
6902-201A	2000x1000x220mm (code 6900-0201 and 6900-1201)	1120	560	755-780	535-560	100
6902-202A	2000x1500x250mm (code 6900-0202 and 6900-1202)	1120	840	755-780	505-530	100

High stands

Code	For granite surface plate	W	D	H (with granite surface plate)	h (without granite surface plate)	W1
6902-64H	630x400x80mm (code 6900-064 and 6900-164)	352	224	1000-1025	920-945	80
6902-66H	630x630x100mm (code 6900-066 and 6900-166)	352	352	1000-1025	900-925	80
6902-85H	800x500x100mm (code 6900-085 and 6900-185)	448	280	1000-1025	900-925	80
6902-106H	1000x630x140mm (code 6900-0106 and 6900-1106)	560	352	1000-1025	860-885	80
6902-101H	1000x1000x150mm (code 6900-0101 and 6900-1101)	560	560	1000-1025	850-875	80
6902-128H	1200x800x160mm (code 6900-0128 and 6900-1128)	672	448	1000-1025	840-865	80
6902-161H	1600x1000x180mm (code 6900-0161 and 6900-1161)	896	560	1000-1025	820-845	80
6902-201H	2000x1000x220mm (code 6900-0201 and 6900-1201)	1120	560	1000-1025	780-805	100
6902-202H	2000x1500x250mm (code 6900-0202 and 6900-1202)	1120	840	1000-1025	750-775	100

HARDENED SURFACES

HIGH PRECISION

STRONG MAGNETIC FORCE

MAGNETIC RECTANGULAR BLOCKS

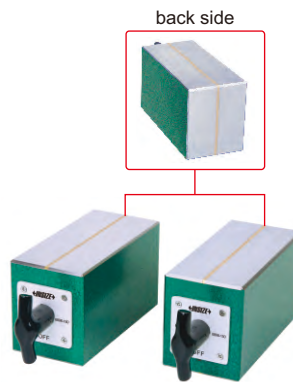
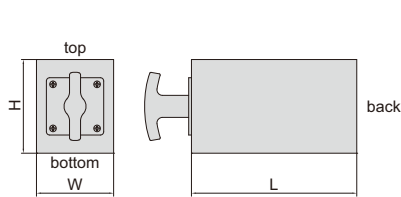

6898-150

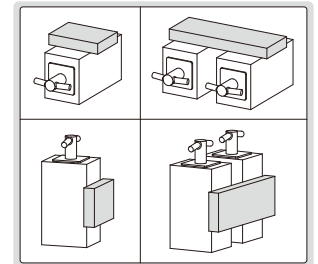

- For grinding, light milling, drilling and inspection of round and square jobs
- Hardened, high accuracy, strong magnetic force
- Working surfaces are hardened to HRC58-62
- Magnetic force on top, bottom and back sides
- Supplied in matched pair

Code	Size (LxWxH)	Magnetic force	Parallelism of top to bottom side	Squareness of top and bottom to back side	Height difference of a matched pair
6898-100	100x70x70mm	100kgf	5µm	5µm	5µm
6898-150	150x70x85mm	125kgf	5µm	5µm	5µm

V-BLOCK SETS



6896-10



6896-11

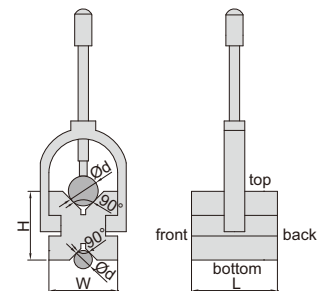

- Hold cylindrical workpieces for inspection and machining
- Two V-blocks per set
- Made of alloy steel
- Hardened to HRC60±2
- V groove on the top for large shafts
- V groove on the bottom for small shafts (except 6896-10)

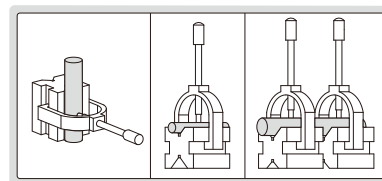

Code	Size (LxWxH)	Range of shafts (Ød)	Parallelism of both V grooves to top and bottom sides	Squareness of both V grooves to front and back sides	Height difference of a matched pair
6896-10	25x20x20mm	3-20mm	3µm	3µm	3µm
6896-11	50x40x40mm	5-30mm	5µm	5µm	5µm
6896-12	80x63x63mm	7-63mm	5µm	5µm	5µm
6896-13	100x80x80mm	7-80mm	5µm	5µm	5µm
6896-14	70x140x140mm	9-140mm	5µm	5µm	5µm

V-BLOCK SET

SIDE LIE-DOWN USE IS POSSIBLE

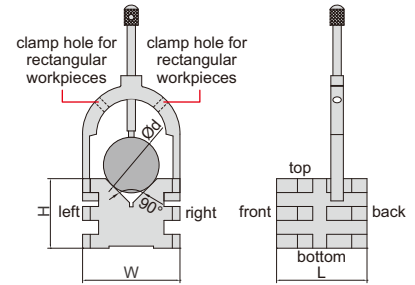
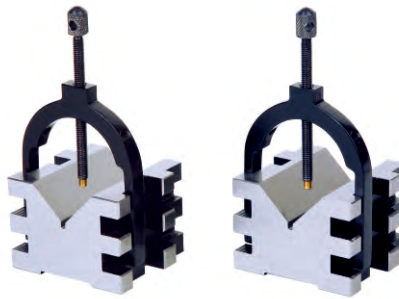
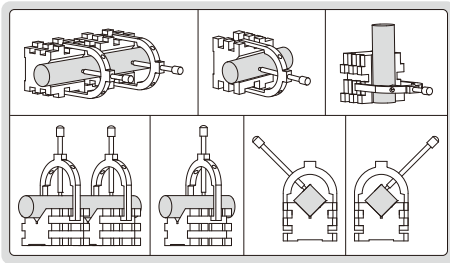

6802-1

- Hold cylindrical or rectangular workpieces for inspection and machining
- Two V-blocks per set
- Made of alloy steel
- Hardened to HRC60±2
- Applicable for cylinder with diameter (Ød): 5-50mm
- Applicable for rectangular workpieces with thickness: ≤35mm

Code	Size (LxWxH)	Parallelism of V groove to top, bottom, left, right sides	Squareness of V groove to front and back sides	Height difference of a matched pair
6802-1	65x70x50mm	5µm	5µm	5µm

V-BLOCK SETS

SIDE LIE-DOWN USE IS POSSIBLE

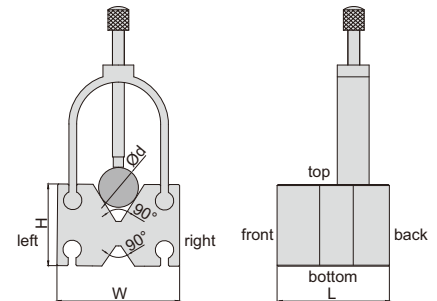
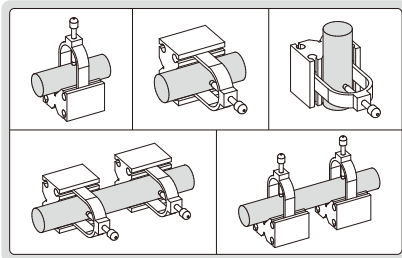

6803-1

- Hold cylindrical workpieces for inspection and machining
- Two V-blocks per set
- Made of alloy steel
- Hardened to HRC60±2
- V groove on the top for large shafts
- V groove on the bottom for small shafts

Code	Size (LxWxH)	Range of shafts (Ød)	Parallelism of both V grooves to top, bottom, left, right sides	Squareness of both V grooves to front and back sides	Height difference of a matched pair
6803-1	55x60x40mm	4-35mm	5µm	5µm	5µm
6803-2	65x70x45mm	4-47mm	5µm	5µm	5µm

V-BLOCK

the adjustable screw can support the block and prevent tilting

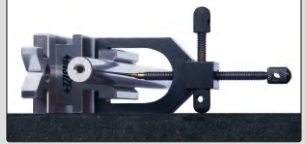

- Hold cylindrical workpieces for inspection and machining
- Made of alloy steel
- Hardened to HRC60±2

side groove is for shouldered studs and pins

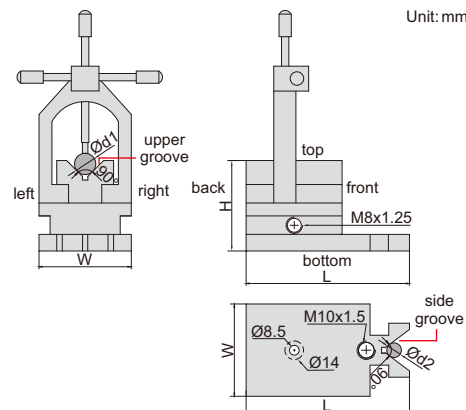

Unit: mm



6804-M2

Code	Size (LxWxH)	Range of shafts (Ød1 and Ød2)	Parallelism of upper groove to bottom, left and right sides	Squareness of upper groove to back side	Parallelism of side groove to back side
6804-M2	90x48x48mm	5-33mm	5µm	5µm	5µm

V-BLOCK SETS

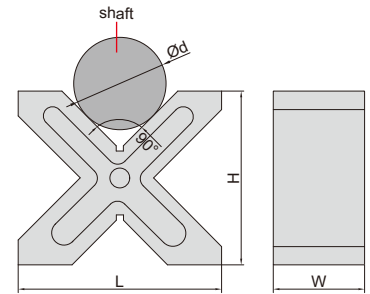
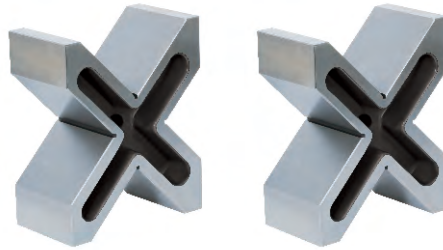
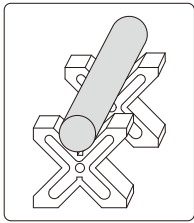

- For positioning cylindrical workpieces
- Two V-blocks per set
- Each V-block has four 90° V-grooves
- Hardness HB170-240

6805-2

Code	Size (L×H×W)	Range of shafts (Ød)	Parallelism of four V grooves to all sides	Height difference of a matched pair
6805-1	150×130×75mm	8-120mm	15µm	20µm
6805-2	200×170×90mm	12-180mm	15µm	20µm

V-BLOCK SETS

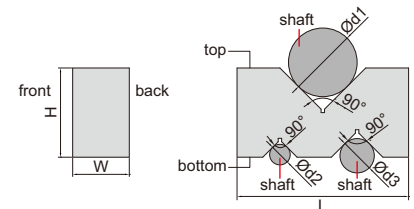
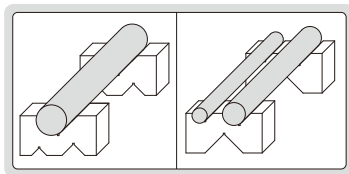

- Two V-blocks per set
- Made of hardened tool steel

6887-3

Code	Size (LxWxH)	Range of shafts (Ød1)	Range of shafts (Ød2)	Range of shafts (Ød3)	Code	Parallelism of three V grooves to top and bottom sides	Height difference of a matched pair
6887-1	50x19x24mm	3-32mm	3-16mm	3-22mm	6887-1	5µm	5µm
6887-2	75x24x35mm	3-50mm	3-20mm	3-32mm	6887-2	5µm	5µm
6887-3	100x33x52mm	3-68mm	3-26mm	3-40mm	6887-3	5µm	5µm
6887-4	125x44x69mm	3-87mm	3-34mm	3-50mm	6887-4	5µm	5µm

ROLLER BEARING V-BLOCK SETS

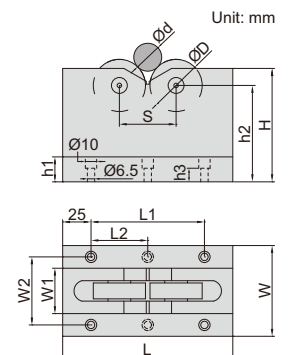
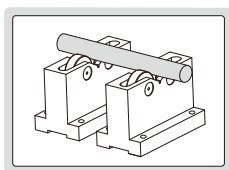

- Runout accuracy: 5µm
- Parallelism of bearings to bottom: 12µm
- Two V-blocks per set
- Workpieces don't get damaged due to bearings
- Suitable for heavy workpieces

6888-1

Code	Size (LxWxH)	Code of bearings	Diameter of bearings (ØD)	Range of shafts (Ød)	Load capacity	Code	W1	W2	h1	h2	h3	L1	L2	S
6888-1	150x60x100mm	16004 ZZ	42mm	25-70mm	500kg									
6888-2	150x80x100mm	6303 ZZ	47mm	5-55mm	1000kg									
6888-3	230x100x150mm	6306 ZZ	72mm	70-200mm	1000kg									

Code	W1	W2	h1	h2	h3	L1	L2	S
6888-1	22	44	20	85	12	100	-	60
6888-2	40	60	22	85	12	100	-	50
6888-3	60	80	30	124	20	180	90	120

GRANITE V-BLOCK SETS

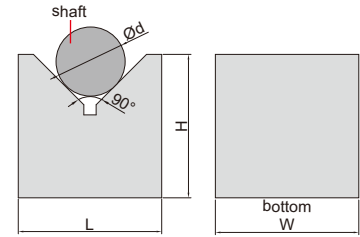
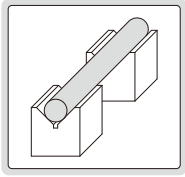

Two V-blocks per set

6897-1

Code	Size (LxWxH)	Range of shafts (Ød)	Parallelism of V groove to bottom	Height difference of a matchet pair
6897-1	70x50x70mm	6-75mm	4µm	5µm
6897-2	100x50x70mm	6-84mm	4µm	5µm

MAGNETIC V-BLOCKS (PROFESSIONAL TYPE)

HARDENED SURFACES

HIGH PRECISION

STRONG MAGNETIC FORCE

12

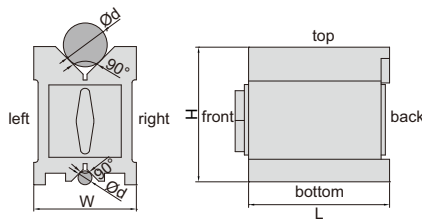

6889-11

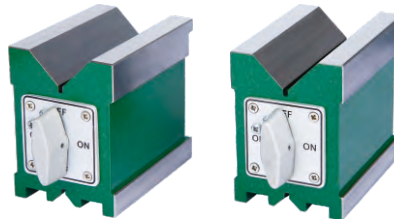

6889-1

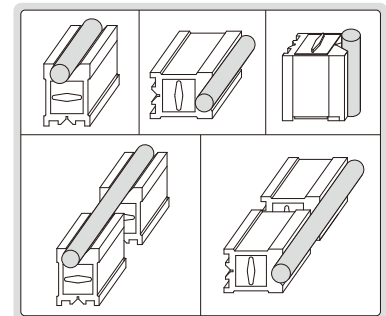

- Hardened, high accuracy, strong magnetic force, for grinding, light milling, drilling and inspection of round and square workpieces
- All working surfaces are hardened to HRC60±2
- Magnetic force on top, bottom and two V grooves
- V groove on the top for large shafts
- V groove on the bottom for small shafts
- Suitable for cast iron surface plates and granite surface plates

Individual

Code	Size (LxWxH)	Range of shafts (Ød)	Magnetic force	Parallelism of V grooves to top, bottom, left, right sides	Squareness of V grooves to back side
6889-11	75x56x75mm	5-40mm	85kgf	5µm	5µm
6889-22	100x70x95mm	5-65mm	150kgf	5µm	5µm
6889-33	150x75x100mm	5-70mm	190kgf	6µm	6µm
6889-55	160x125x130mm	5-140mm	220kgf	12µm	12µm
6889-44	200x125x150mm	10-140mm	400kgf	12µm	12µm

Matched pair

Code	Size (LxWxH)	Range of shafts (Ød)	Magnetic force	Parallelism of V grooves to top, bottom, left, right sides	Squareness of V grooves to back side	Height difference of a matched pair
6889-1	75x56x75mm	5-40mm	85kgf	5µm	5µm	5µm
6889-2	100x70x95mm	5-65mm	150kgf	5µm	5µm	5µm
6889-3	150x75x100mm	5-70mm	190kgf	6µm	6µm	6µm
6889-5	160x125x130mm	5-140mm	220kgf	12µm	12µm	12µm
6889-4	200x125x150mm	10-140mm	400kgf	12µm	12µm	12µm

ATTENTION: NOT SUITABLE FOR STEEL OR IRON SURFACES, OTHERWISE THE MAGNETIC FORCE WILL BE REDUCED

ATTENTION: NOT HARDENED

MAGNETIC V-BLOCK (ECONOMIC TYPE)

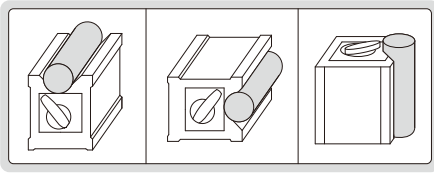

6890-702

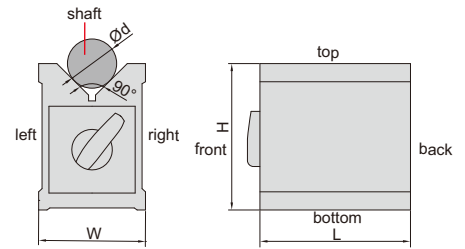

- Hold cylindrical workpieces for inspection and machining
- Supplied in single piece
- Not hardened
- Not suitable for steel or iron surfaces, otherwise the magnetic force will be reduced

Code	Size (LxWxH)	Range of shafts ($\varnothing d$)	Magnetic force	Parallelism of V groove to top, bottom, left and right sides	Squareness of V groove to back side
6890-702	70x60x73mm	6-44mm	56kgf	10 μ m	10 μ m

ATTENTION: NOT SUITABLE FOR STEEL OR IRON SURFACES, OTHERWISE THE MAGNETIC FORCE WILL BE REDUCED

ATTENTION: NOT HARDENED

MAGNETIC V-BLOCKS (ECONOMIC TYPE)

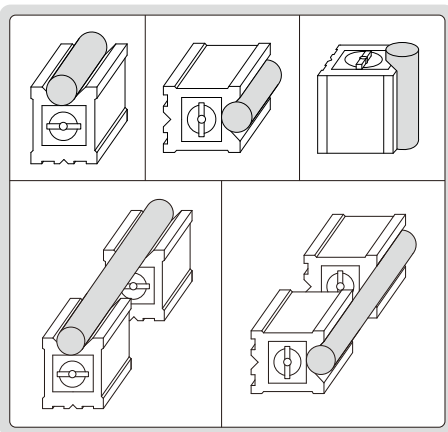

6801-1201



6801-1

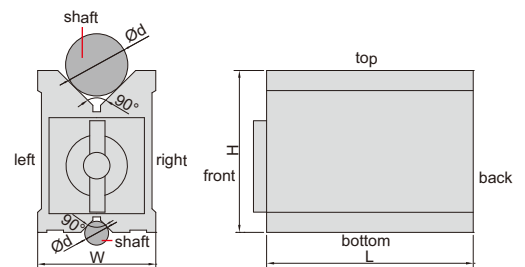

- Hold cylindrical workpieces for inspection and machining
- Not hardened
- V groove on the top for large shafts
- V groove on the bottom for small shafts
- Not suitable for steel or iron surfaces, otherwise the magnetic force will be reduced

Individual

Code	Size (LxWxH)	Range of shafts ($\varnothing d$)	Magnetic force	Parallelism of V grooves to top, bottom, left, right side	Squareness of V grooves to back side
6801-1201	80x70x95mm	6-67mm	64kgf	10 μ m	10 μ m
6801-1202	100x70x95mm	6-67mm	80kgf	10 μ m	10 μ m
6801-1203	120x70x95mm	6-67mm	96kgf	10 μ m	10 μ m

Matched pair

Code	Size (LxWxH)	Range of shafts ($\varnothing d$)	Magnetic force	Parallelism of V grooves to top, bottom, left, right side	Squareness of V grooves to back side	Height difference of a matched pair
6801-1	80x70x95mm	6-67mm	64kgf	10 μ m	10 μ m	10 μ m
6801-2	100x70x95mm	6-67mm	80kgf	10 μ m	10 μ m	10 μ m
6801-3	120x70x95mm	6-67mm	96kgf	10 μ m	10 μ m	10 μ m

MAGNETIC V-BLOCK SETS

ATTENTION: NOT HARDENED, DO NOT ROTATE WORKPIECES ON V-BLOCKS

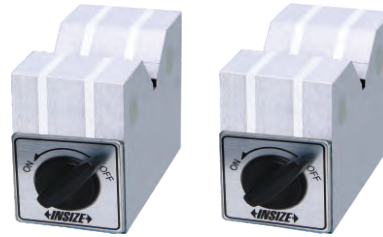
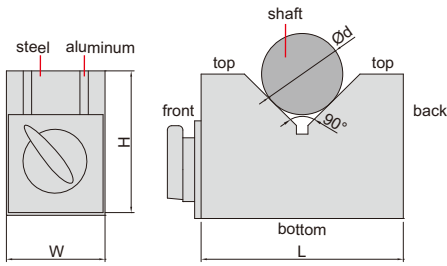

ATTENTION: LOW MAGNETIC FORCE

- Hold cylindrical workpieces for inspection, not suitable for machining due to low magnetic force
- Two V-blocks per set
- Hardness HRB70

6891-1

Code	Size (LxWxH)	Range of shafts (Ød)	Magnetic force	Parallelism of V groove to bottom and back sides	Height difference of a matched pair
6891-1	70x40x50mm	6-46mm	8kgf	10µm	10µm
6891-3	150x50x100mm	6-125mm	14kgf	10µm	10µm

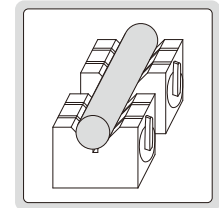

MAGNETIC SQUARE WITH V GROOVE

ATTENTION: NOT HARDENED, DO NOT ROTATE WORKPIECES ON V-BLOCKS

12

- Hold flat and cylindrical workpieces for inspection and machining
- Magnetic force on top, left, right and V grooves
- Parallelism and squareness of top, bottom, left, right and back: 20µm
- Parallelism and squareness of V grooves to top, bottom, left, right and back: 20µm



6539-100

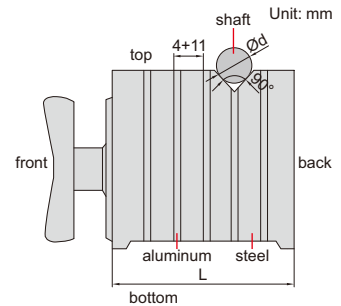
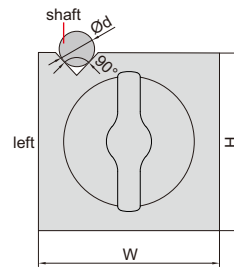

Code	Size (LxWxH)	Magnetic force of V grooves		Magnetic force of top, left and right sides		Range of shafts (Ød)
		On granite surface plate	On cast iron plate	On granite surface plate	On cast iron plate	
6539-100	100x100x100mm	30kgf	25kgf	50kgf	30kgf	5-35mm

MAGNETIC INDUCTION V-BLOCK

ATTENTION: NOT HARDENED, DO NOT ROTATE WORKPIECES ON V-BLOCKS

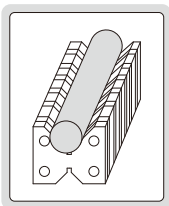

- Hold cylindrical workpieces for inspection and machining
- To be used on magnetic chucks
- Supplied in single piece
- V groove on the top for large shafts
- V groove on the bottom for small shafts
- Hardness HRB70



6892-1

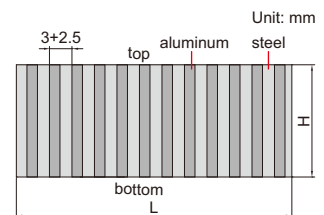
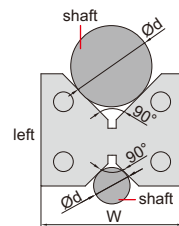

Code	Size (LxWxH)	Range of shafts (Ød)	Pole pitch	Parallelism of both V grooves to top and bottom sides
6892-1	110x60x48mm	6-50mm	3+2.5mm	10µm

ATTENTION: NOT HARDENED, DO NOT ROTATE WORKPIECES ON V-BLOCKS

MAGNETIC INDUCTION V-BLOCK SET

- Hold cylindrical workpieces for inspection and machining
- To be used on magnetic chucks
- Two V-blocks per set
- V groove on the top for large shafts
- V groove on the bottom for small shafts
- Hardness HRB70
- Copper magnetic strips

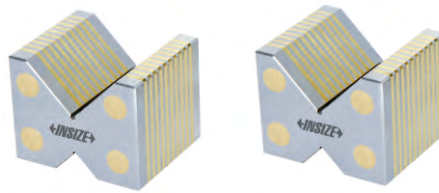

6878-1

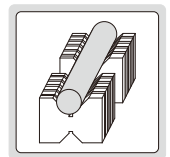
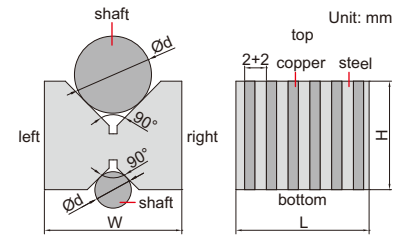

Code	Size (LxWxH)	Range of shafts ($\varnothing d$)	Pole pitch	Parallelism of both V grooves to top and bottom sides	Height difference of a matched pair
6878-1	49x58x46mm	5-56mm	2+2mm	10 μ m	10 μ m

ATTENTION: NOT HARDENED, DO NOT ROTATE WORKPIECES ON V-BLOCKS

MAGNETIC INDUCTION V-BLOCK SET (ECONOMIC TYPE)

- Hold cylindrical workpieces for inspection and machining
- To be used on magnetic chucks
- Two V-blocks per set
- V groove on the top for large shafts
- V groove on the bottom for small shafts
- Hardness HRB70



6899-1

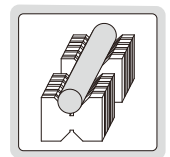
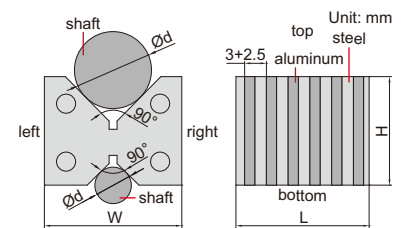

Code	Size (LxWxH)	Range of shafts ($\varnothing d$)	Pole pitch	Parallelism of both V grooves to top and bottom sides	Height difference of a matched pair
6899-1	55x60x48mm	6-50mm	3+2.5mm	10 μ m	10 μ m

ATTENTION: NOT HARDENED

PERMANENT MAGNETIC CHUCK

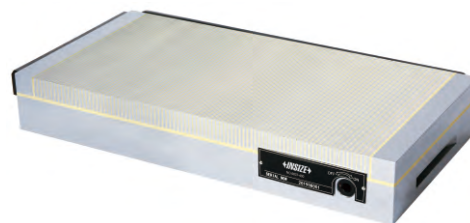

6537-400

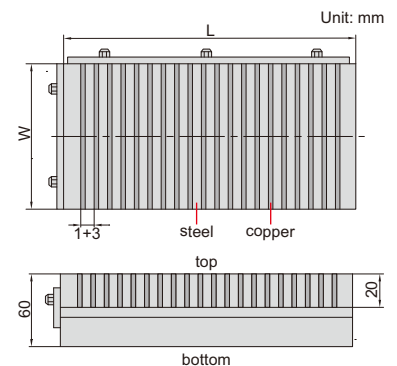

Code	Table size (LxW)	Magnetic force	Pole pitch	Parallelism of top to bottom
6537-400	400x200mm	12kgf/cm ²	1+3mm	0.005mm/100mm

PARALLEL SET

screws and wrench are included



6531-25

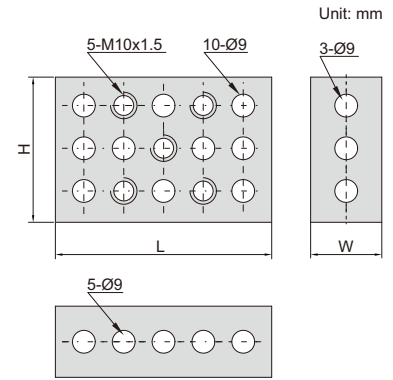

- Pairs of matched blocks for positioning and set-up
- Screws and wrench are included
- Hardness HRC 55-62

Code	Size (L×H×W)	Size accuracy	Squareness	Parallelism	Height difference of a matched pair
6531-25	75×50×25mm	10µm	7µm/25mm	10µm	10µm

PARALLEL SETS

12

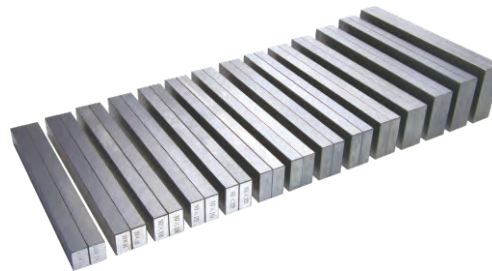

6533-144

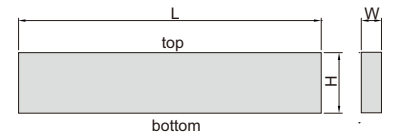

- Parallelism between top and bottom: 5µm
- Height difference of a matched pair: 5µm
- Made of alloy tool steel
- Hardened to HRC55-60

Code	Parallels per set	Length (L)	Thickness (W)	Height (H)
6533-6	6 pairs	200mm	9.5mm	35, 40, 45, 50, 55, 58mm
6533-8	8 pairs	160mm	8mm	12, 17, 22, 25, 28, 32, 36, 38mm
6533-81	8 pairs	200mm	8mm	17, 22, 26, 28, 32, 36, 38, 42mm
6533-9	9 pairs	160mm	4mm	10, 14, 18, 22, 26, 30, 34, 38, 42mm
6533-10	10 pairs	150mm	3mm	13, 16, 19, 22, 25, 28, 31, 35, 38, 41mm
6533-144	14 pairs	150mm	10mm	14, 16, 18, 20, 22, 24, 26, 28, 30, 32, 35, 40, 45, 50mm

PARALLEL SET

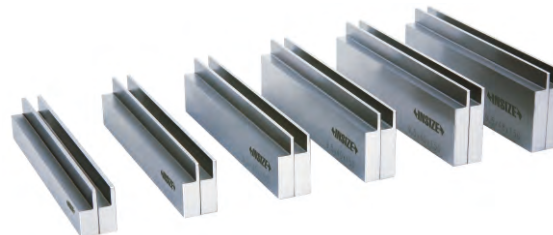
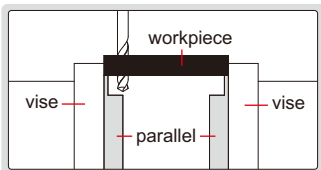

6534-6

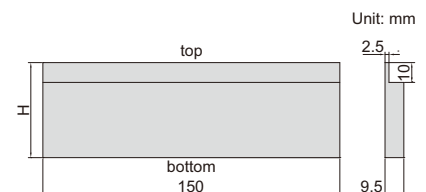

- Parallelism between top and bottom: 5µm
- Height difference of a matched pair: 5µm
- Made of alloy tool steel
- Hardened to HRC55-60

Code	Parallels per set	Height (H)
6534-6	6 pairs	25, 30, 35, 40, 45, 48mm

PARALLELS



6512-2210A

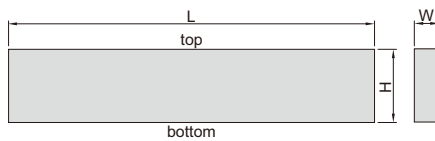

- Made of alloy tool steel
- Hardened to HRC55-60
- Supplied in pair

L=100mm

Code	H×W	Parallelism between top and bottom	Height difference of a matched pair
6512-52	5×2mm	7µm	7µm
6512-102	10×2mm	5µm	5µm
6512-152	15×2mm	5µm	5µm
6512-202	20×2mm	5µm	5µm
6512-63	6×3mm	7µm	7µm
6512-113	11×3mm	5µm	5µm
6512-163	16×3mm	5µm	5µm
6512-213	21×3mm	5µm	5µm
6512-74	7×4mm	7µm	7µm
6512-124	12×4mm	5µm	5µm
6512-174	17×4mm	5µm	5µm
6512-224	22×4mm	5µm	5µm
6512-85	8×5mm	7µm	7µm
6512-135	13×5mm	5µm	5µm
6512-185	18×5mm	5µm	5µm
6512-235	23×5mm	5µm	5µm
6512-96	9×6mm	7µm	7µm
6512-146	14×6mm	5µm	5µm
6512-196	19×6mm	5µm	5µm
6512-246	24×6mm	5µm	5µm

L=125mm	L=150mm	L=200mm	H×W	Parallelism between top and bottom	Height difference of a matched pair
6512-118	6512-1181	6512-1182	11×8mm	5µm	5µm
6512-168	6512-1681	6512-1682	16×8mm	5µm	5µm
6512-218	6512-2181	6512-2182	21×8mm	5µm	5µm
6512-268	6512-2681	6512-2682	26×8mm	5µm	5µm
6512-318	6512-3181	6512-3182	31×8mm	5µm	5µm
6512-368	6512-3681	6512-3682	36×8mm	5µm	5µm
6512-1310	6512-13101	6512-13102	13×10mm	5µm	5µm
6512-1810	6512-18101	6512-18102	18×10mm	5µm	5µm
6512-2310	6512-23101	6512-23102	23×10mm	5µm	5µm
6512-2810	6512-28101	6512-28102	28×10mm	5µm	5µm
6512-3310	6512-33101	6512-33102	33×10mm	5µm	5µm
6512-3810	6512-38101	6512-38102	38×10mm	5µm	5µm
6512-1512	6512-15121	6512-15122	15×12mm	5µm	5µm
6512-2012	6512-20121	6512-20122	20×12mm	5µm	5µm
6512-2512	6512-25121	6512-25122	25×12mm	5µm	5µm
6512-3012	6512-30121	6512-30122	30×12mm	5µm	5µm
6512-3512	6512-35121	6512-35122	35×12mm	5µm	5µm
6512-4012	6512-40121	6512-40122	40×12mm	5µm	5µm
6512-1714	6512-17141	6512-17142	17×14mm	5µm	5µm
6512-2214	6512-22141	6512-22142	22×14mm	5µm	5µm
6512-2714	6512-27141	6512-27142	27×14mm	5µm	5µm
6512-3214	6512-32141	6512-32142	32×14mm	5µm	5µm
6512-3714	6512-37141	6512-37142	37×14mm	5µm	5µm
6512-4214	6512-42141	6512-42142	42×14mm	5µm	5µm

To be continued

Continued from previous page

L=150mm

Code	H×W	Parallelism between top and bottom	Height difference of a matched pair
6512-1410A	14×10mm	5µm	5µm
6512-1610A	16×10mm	5µm	5µm
6512-1810A	18×10mm	5µm	5µm
6512-2010A	20×10mm	5µm	5µm
6512-2210A	22×10mm	5µm	5µm
6512-2410A	24×10mm	5µm	5µm
6512-2610A	26×10mm	5µm	5µm
6512-2810A	28×10mm	5µm	5µm
6512-3010A	30×10mm	5µm	5µm
6512-3210A	32×10mm	5µm	5µm
6512-3510A	35×10mm	5µm	5µm
6512-4010A	40×10mm	5µm	5µm
6512-4510A	45×10mm	5µm	5µm
6512-5010A	50×10mm	5µm	5µm

L=160mm

Code	H×W	Parallelism between top and bottom	Height difference of a matched pair
6512-104A	10×4mm	5µm	5µm
6512-144A	14×4mm	5µm	5µm
6512-184A	18×4mm	5µm	5µm
6512-224A	22×4mm	5µm	5µm
6512-264A	26×4mm	5µm	5µm
6512-304A	30×4mm	5µm	5µm
6512-344A	34×4mm	5µm	5µm
6512-384A	38×4mm	5µm	5µm
6512-424A	42×4mm	5µm	5µm
6512-128A	12×8mm	5µm	5µm
6512-178A	17×8mm	5µm	5µm
6512-228A	22×8mm	5µm	5µm
6512-258A	25×8mm	5µm	5µm
6512-288A	28×8mm	5µm	5µm
6512-328A	32×8mm	5µm	5µm
6512-368A	36×8mm	5µm	5µm
6512-388A	38×8mm	5µm	5µm

L=200mm

Code	H×W	Parallelism between top and bottom	Height difference of a matched pair
6512-178B	17×8mm	5µm	5µm
6512-228B	22×8mm	5µm	5µm
6512-268B	26×8mm	5µm	5µm
6512-288B	28×8mm	5µm	5µm
6512-328B	32×8mm	5µm	5µm
6512-368B	36×8mm	5µm	5µm
6512-388B	38×8mm	5µm	5µm
6512-428B	42×8mm	5µm	5µm

12

PARALLEL SETS

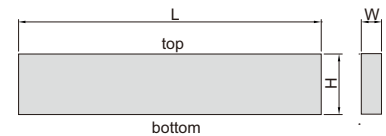
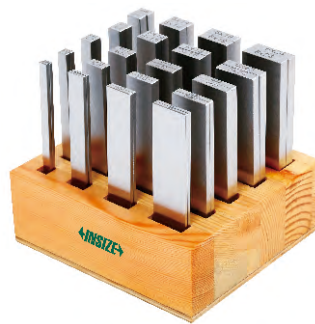

- Parallelism between top and bottom: 5µm
- Height difference of a matched pair: 5µm
- Made of alloy tool steel
- Hardened to HRC55-60

6511-20

Code	Parallels per set	Length (L)	Height (H)×Thickness (W)
6511-20	20 pairs	100mm	5×2*, 10×2, 15×2, 20×2, 6×3*, 11×3, 16×3, 21×3, 7×4*, 12×4, 17×4, 22×4, 8×5*, 13×5, 18×5, 23×5, 9×6*, 14×6, 19×6, 24×6mm
6511-24	24 pairs	125mm	11×8, 16×8, 21×8, 26×8, 31×8, 36×8, 13×10, 18×10, 23×10, 28×10, 33×10, 38×10, 15×12, 20×12, 25×12, 30×12, 35×12, 40×12, 17×14, 22×14, 27×14, 32×14, 37×14, 42×14mm
6511-241	24 pairs	150mm	11×8, 16×8, 21×8, 26×8, 31×8, 36×8, 13×10, 18×10, 23×10, 28×10, 33×10, 38×10, 15×12, 20×12, 25×12, 30×12, 35×12, 40×12, 17×14, 22×14, 27×14, 32×14, 37×14, 42×14mm

* Parallelism between top and bottom and height difference of a matched pair of 5×2mm, 6×3mm, 7×4mm, 8×5mm and 9×6mm in 6511-20 is 7µm

GRANITE PARALLEL SET

- Made of granite, hard and no rusty, no dimensional change over time or temperature change
- Two parallels per set



4143-250

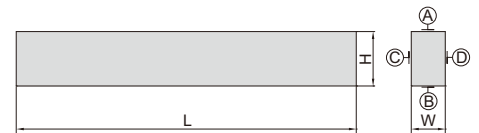

Code	Size (LxWxH)	Parallelism between A and B	Parallelism between C and D	Height difference of a matched pair
4143-250	250x25x40mm	3µm	3µm	3µm

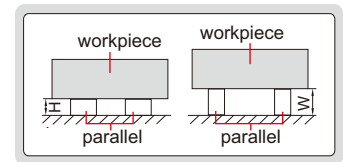

ATTENTION:
NOT HARDENED

MAGNETIC INDUCTION PARALLEL SET

- To be used on magnetic chucks
- Two parallels per set
- Hardness HRB70
- Copper magnetic strips

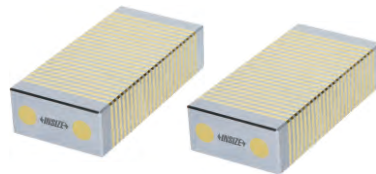

6879-1

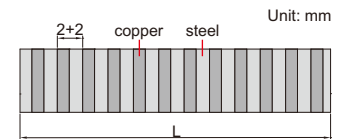
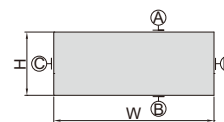

Code	Size (LxWxH)	Pole pitch	Parallelism between A and B	Parallelism between C and D	Height difference of a matched pair
6879-1	100x50x25mm	2+2mm	10µm	10µm	10µm

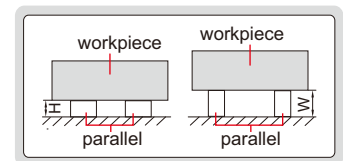

ATTENTION:
NOT HARDENED

MAGNETIC INDUCTION PARALLEL SETS (ECONOMIC TYPE)

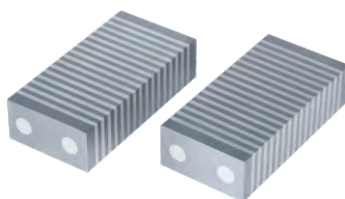

6894-1

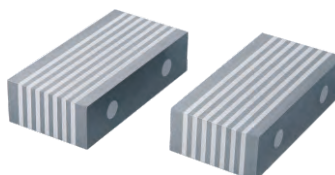

6894-2

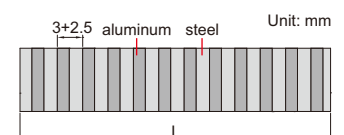
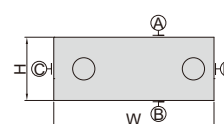

6894-1

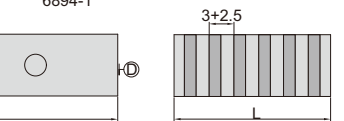
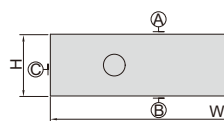

6894-2

- To be used on magnetic chucks
- Two parallels per set
- Hardness HRB70

Code	Size (LxWxH)	Pole pitch	Parallelism between A and B	Parallelism between C and D	Height difference of a matched pair
6894-1	100x50x25mm	3+2.5mm	10µm	10µm	10µm
6894-2	50x100x25mm	3+2.5mm	10µm	10µm	10µm

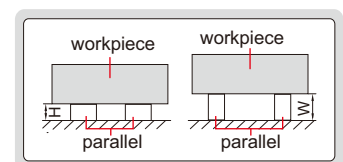

ANGLE PLATE SETS

- For angle set-up in tooling, production and inspection
- Hardness HRC52

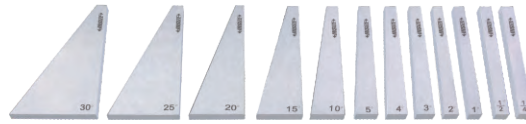

4006-12

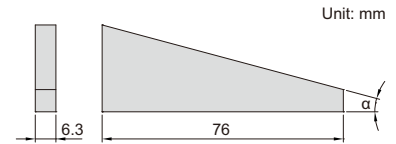

Code	Angle plates included	Angle α	Accuracy
4006-10	10 pcs	1°, 2°, 3°, 4°, 5°, 10°, 15°, 20°, 25°, 30°	±20 seconds
4006-12	12 pcs	1/4°, 1/2°, 1°, 2°, 3°, 4°, 5°, 10°, 15°, 20°, 25°, 30°	±20 seconds

ANGLE PLATE SET

12

- For angle set-up in tooling, production and inspection
- Made of tool steel
- Hardness HRC55



4004-9

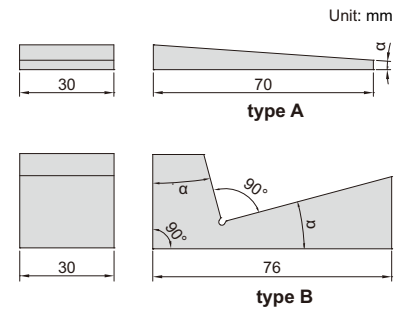

Code	Angle plates included	Angle α	Type	Accuracy
4004-9	9 pcs	1/2°, 1°, 2°, 3°, 4°, 5°	type A	±30 seconds
		10°, 15°, 30°	type B	±50 seconds

ADJUSTABLE ANGLE BLOCKS

- Made of hardened tool steel
- With locking screw
- Accuracy of angle: 10 minutes



6535-30

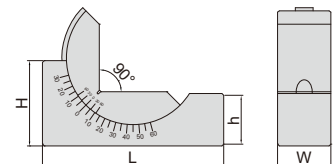

Code	Size (LxWxH)	h	Adjustable angle	Graduation of angle
6535-25	75x25x36mm	25mm	30°~0°~60°	10 minutes
6535-30	102x30x49mm	30mm	30°~0°~60°	10 minutes

RIGHT ANGLE PLATE

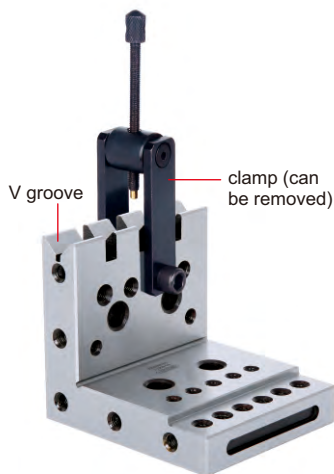

6547-1

- Made of alloy steel
- Hardened to HRC60±2
- V groove for cylinders
- Parallelism and squareness between A, B, C, D, E, F, G and H: 10µm
- Parallelism and squareness of V groove to A, B, C, D, E, F, G and H: 10µm

Code	Size (LxWxH)
6547-1	100x100x115mm

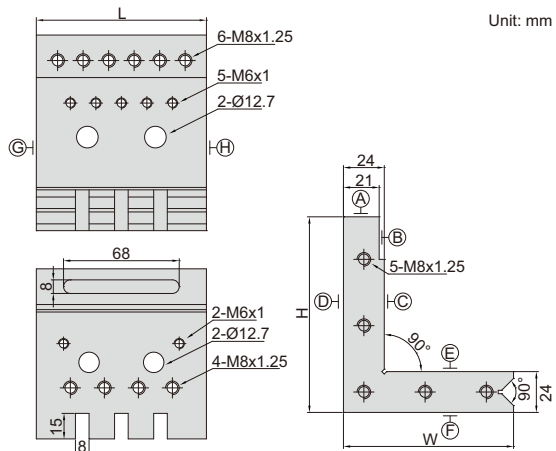

12

RIGHT ANGLE PLATE

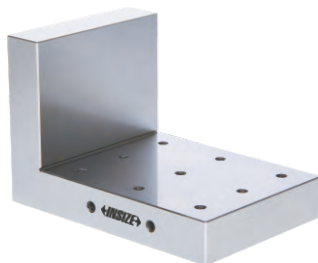

6548-1

- Made of tool steel
- Hardened to HRC60±2
- Squareness or parallelism between A, B, C and D: 5µm

Code	Size (LxWxH)
6548-1	100x100x150mm

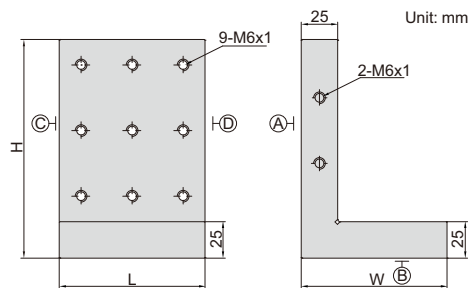

RIGHT ANGLE PLATE



6549-1

- Made of tool steel
- Hardened to HRC56-58
- Parallelism between A, B, C, D, E and F: 3µm
- Squareness between A, B, C, D, E and F: 5µm

Code	Size (LxWxH)
6549-1	150x63x150mm

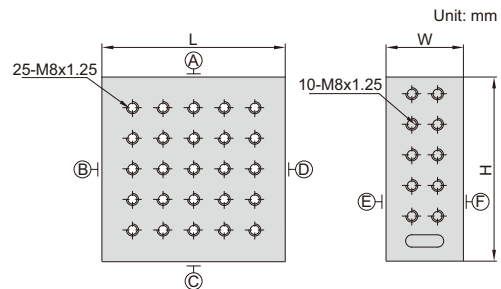

SINE BARS

CAN BE CUSTOMIZED

HIGH PRECISION

the front and back ends and two sides have mounting holes to install plate

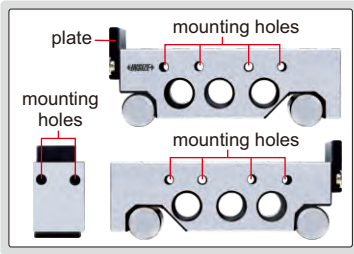

4155-100

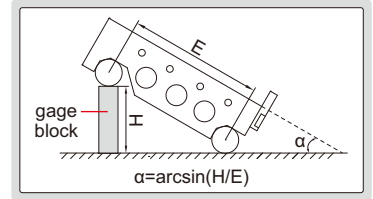
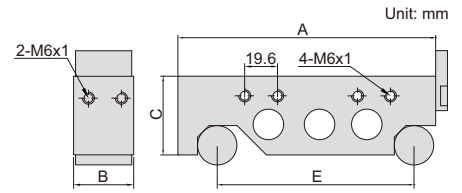

- Made of alloy tool steel

Code	Roller distance (E)	Table size (AxB)	C	Accuracy of α at 30°
4155-100	100mm	130x30mm	40mm	± 5 seconds
4155-200	200mm	230x30mm	40mm	± 5 seconds
4155-300	300mm	345x40mm	50mm	± 8 seconds

COMPOUND SINE TABLE

12



6536-100

- Accuracy of angle: ± 15 seconds
- Made of alloy tool steel
- Hardness HRC58-60

Code	Roller distance (E)	Table size (LxW)	Adjustable angle
6536-100	100mm	150x150mm	0-60°

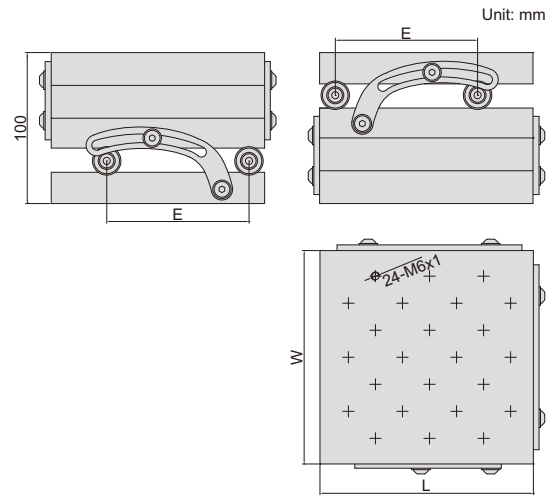

SINE TABLE



6527-100

- Accuracy of angle: ± 15 seconds
- Made of alloy tool steel
- Hardness HRC58-60

Code	Roller distance (E)	Table size (LxW)	Adjustable angle
6527-100	100mm	150x150mm	0-60°

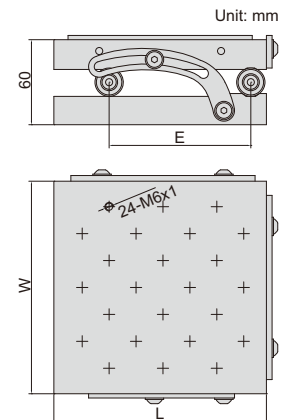

**ATTENTION:
NOT HARDENED**

MAGNETIC SINE TABLE

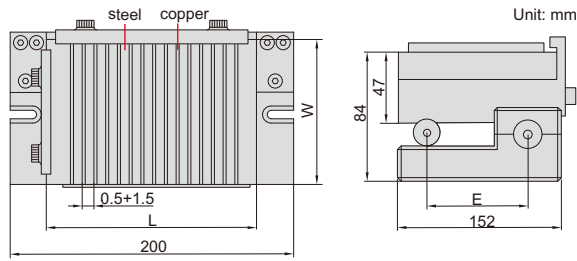

6538-100

Code	Table size (L×W)	Roller distance (E)	Adjustable angle	Accuracy of angle
6538-100	150×150mm	100mm	0-60°	±15 seconds

PRECISION SINE VISE

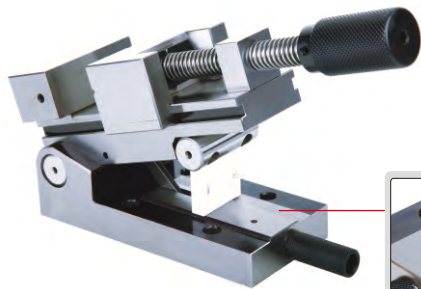

6522-80

There is a 1mm step (accuracy $\pm 0.002\text{mm}$). Gage blocks smaller than 0.5mm are not available. If small gage blocks are needed (for example, 0.25mm), a gage block 1.25mm can be used in order to make $1.25\text{mm} - 1\text{mm} = 0.25\text{mm}$.

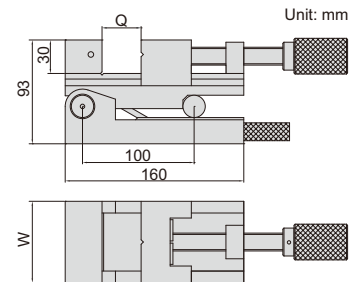

- Parallelism: $3\mu\text{m}/100\text{mm}$
- Squareness: $5\mu\text{m}/100\text{mm}$
- Accuracy of angle: ± 15 seconds
- Made of SKS tool steel, subzero treatment
- Hardness HRC58-60

Code	Jaw opening (Q)	Jaw width (W)	Adjustable angle
6522-80	0-80mm	73mm	0-46°

12

PRECISION SINE VISE

There is a 1mm step (accuracy $\pm 0.002\text{mm}$). Gage blocks smaller than 0.5mm are not available. If small gage blocks are needed (for example, 0.25mm), a gage block 1.25mm can be used in order to make $1.25\text{mm} - 1\text{mm} = 0.25\text{mm}$.

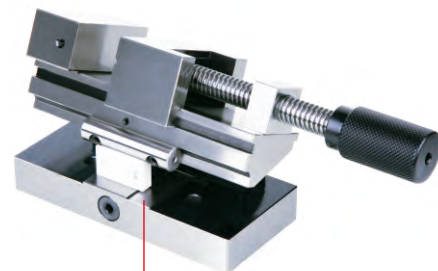

6523-80

- Parallelism: $3\mu\text{m}/100\text{mm}$
- Squareness: $5\mu\text{m}/100\text{mm}$
- Accuracy of angle: ± 15 seconds
- Made of SKS tool steel, subzero treatment
- Hardness HRC58-60

Code	Jaw opening (Q)	Jaw width (W)	Adjustable angle
6523-80	0-80mm	73mm	0-46°

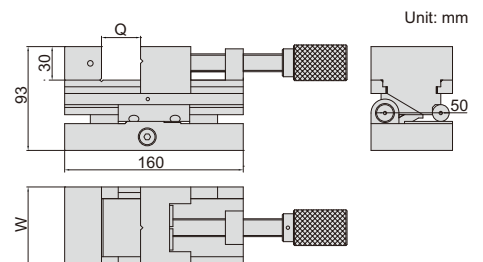

PRECISION COMPOUND SINE VISE

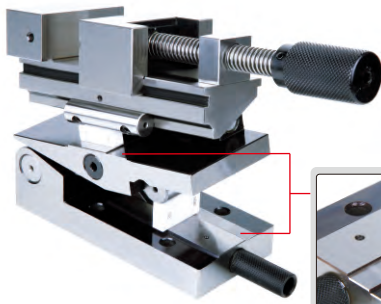

6524-80

There is a 1mm step (accuracy +/-0.002mm). Gage blocks smaller than 0.5mm are not available. If small gage blocks are needed (for example, 0.25mm), a gage block 1.25mm can be used in order to make 1.25mm - 1mm = 0.25mm.

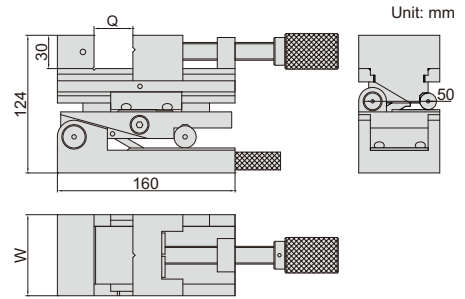

- Parallelism: 3µm/100mm
- Squareness: 5µm/100mm
- Accuracy of angle: ±15 seconds
- Made of SKS tool steel, subzero treatment
- Hardness HRC58-60

Code	Jaw opening (Q)	Jaw width (W)	Adjustable angle
6524-80	0-80mm	73mm	0-46°

PRECISION UNIVERSAL VISE

12

- Horizontal rotary: range 360°, graduation 0.05°
- Vertical incline: range 45°, graduation 0.05°
- With incline adjust knob
- Parallelism and squareness between A, B, C and D: 5µm/100mm, parallelism between D and E at 0°: 10µm/100mm
- Made of tool steel
- Hardness HRC56-58

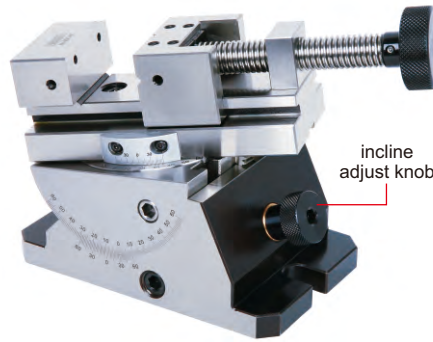

6521-80

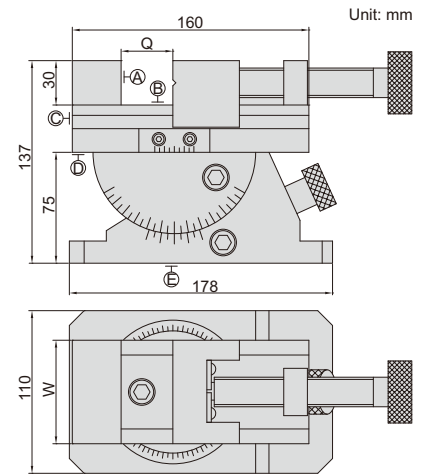

Code	Jaw opening (Q)	Jaw width (W)
6521-80	0-80mm	70mm

PRECISION UNIVERSAL VISE WITH CHUCK

- Horizontal rotary: range 360°, graduation 0.05°
- Vertical incline: range 45°, graduation 0.05°
- With vertical incline adjust knob
- Runout of chuck is less than 0.05mm (test position is at less than 50mm from clamping jaws)
- The clamping jaws of chuck are reversible
- Made of tool steel
- Hardness HRC56-58

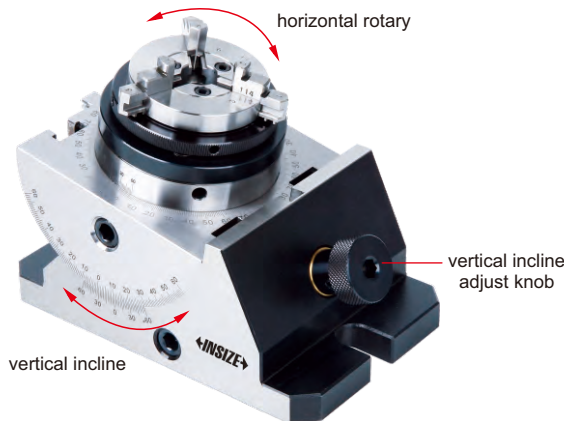

6528-85

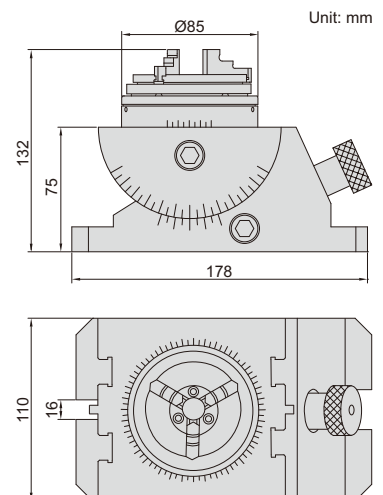

Code	Range of external clamping	Range of internal clamping
6528-85	Ø0.8-Ø63mm	Ø23-Ø58mm

PRECISION VISES

- Parallelism: 8µm/100mm
- Squareness: 10µm/100mm
- Made of alloy steel
- Hardness HRC56-58

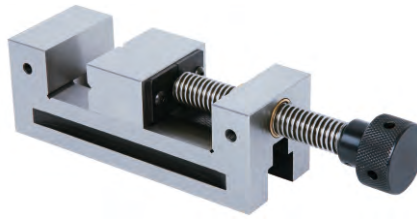

6520-73A

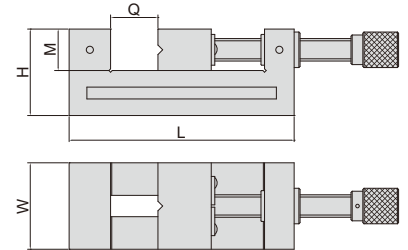

Code	Jaw opening (Q)	Jaw width (W)	L	H	M
6520-73A	0-73mm	63mm	176mm	63mm	30mm
6520-76A	0-76mm	73mm	190mm	73mm	35mm
6520-120A	0-120mm	98mm	255mm	82mm	40mm

PRECISION VISES

- Parallelism: 3µm/100mm
- Squareness: 5µm/100mm
- Made of alloy steel
- Hardness HRC56-58



6526-80

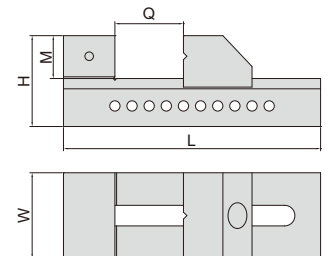

Code	Jaw opening (Q)	Jaw width (W)	Overall length (L)	H	M
6526-80	0-80mm	50mm	150mm	53mm	25mm
6526-100	0-100mm	73mm	190mm	70mm	35mm

Z-AXIS STAGE CODE 6586-60

Unit: mm

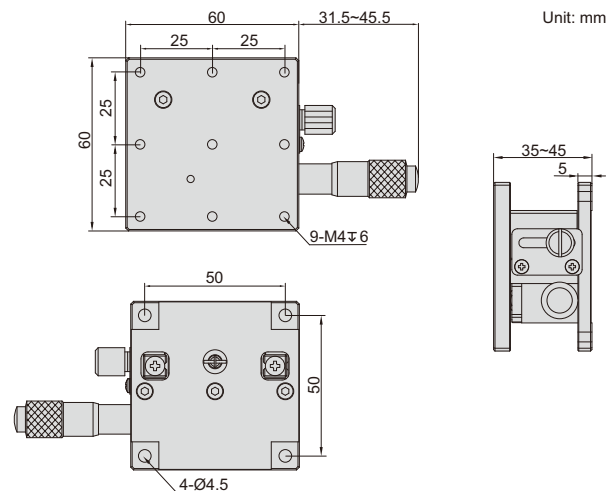

- Cross roller guides, achieve high precision and smooth movement
- Stage made of aluminum alloy

SPECIFICATION

Code	Z-axis displacement	Parallelism of top to bottom surface	Micrometer graduation	Micrometer accuracy	Maximum load	Stage size	Weight
6586-60	10mm	0.05mm	0.01mm	0.02mm	20.4N (3kgf)	60x60mm	0.27kg

X-AXIS STAGES



6582-401

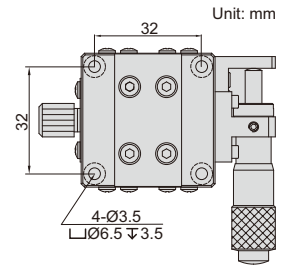
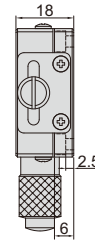
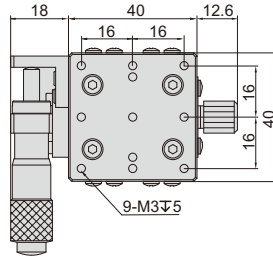

6582-602

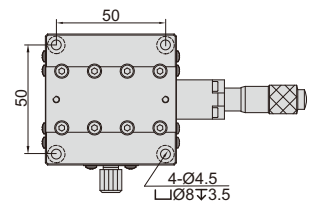
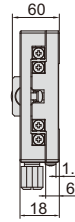
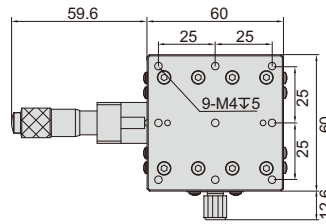

6582-903

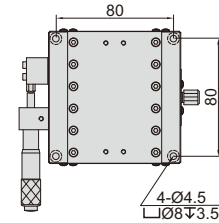
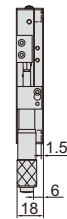
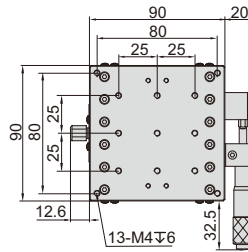

- Cross roller guides, achieve high precision and smooth movement
- Stages made of aluminum alloy

SPECIFICATION (micrometer on the left)

Code	X-axis displacement	Parallelism of top to bottom surface	Micrometer graduation	Micrometer accuracy	Maximum load	Micrometer location	Stage size	Weight
6582-401	±6.5mm	0.02mm	0.01mm	0.01mm	29.4N (3kgf)	left	40x40mm	0.14kg
6582-601	±6.5mm	0.03mm	0.01mm	0.01mm	49N (5kgf)	left	60x60mm	0.24kg
6582-901	±12.5mm	0.03mm	0.01mm	0.02mm	93.1N (9.5kgf)	left	90x90mm	0.47kg
6582-1251	±12.5mm	0.04mm	0.01mm	0.02mm	180N (18.4kgf)	left	125x125mm	1.40kg

SPECIFICATION (micrometer in the middle)

Code	X-axis displacement	Parallelism of top to bottom surface	Micrometer graduation	Micrometer accuracy	Maximum load	Micrometer location	Stage size	Weight
6582-402	±6.5mm	0.02mm	0.01mm	0.01mm	29.4N (3kgf)	middle	40x40mm	0.14kg
6582-602	±6.5mm	0.03mm	0.01mm	0.01mm	49N (5kgf)	middle	60x60mm	0.24kg
6582-902	±12.5mm	0.03mm	0.01mm	0.02mm	93.1N (9.5kgf)	middle	90x90mm	0.47kg
6582-1252	±12.5mm	0.04mm	0.01mm	0.02mm	180N (18.4kgf)	middle	125x125mm	1.40kg

SPECIFICATION (micrometer on the right)

Code	X-axis displacement	Parallelism of top to bottom surface	Micrometer graduation	Micrometer accuracy	Maximum load	Micrometer location	Stage size	Weight
6582-403	±6.5mm	0.02mm	0.01mm	0.01mm	29.4N (3kgf)	right	40x40mm	0.14kg
6582-603	±6.5mm	0.03mm	0.01mm	0.01mm	49N (5kgf)	right	60x60mm	0.24kg
6582-903	±12.5mm	0.03mm	0.01mm	0.02mm	93.1N (9.5kgf)	right	90x90mm	0.47kg
6582-1253	±12.5mm	0.04mm	0.01mm	0.02mm	180N (18.4kgf)	right	125x125mm	1.40kg

XY-AXIS STAGES

Unit: mm



6584-401

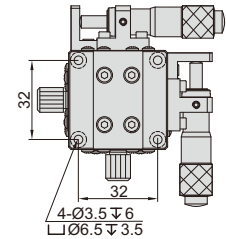
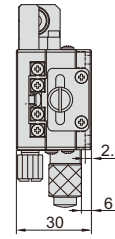
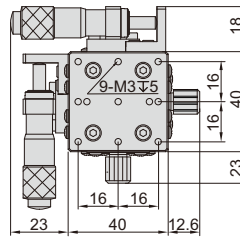

6584-602

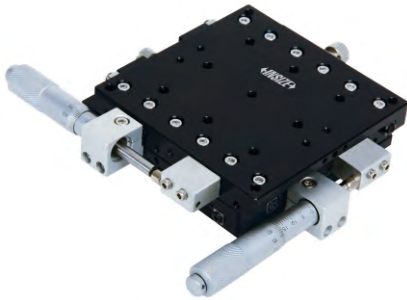
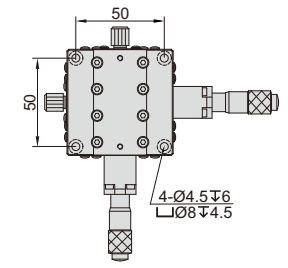
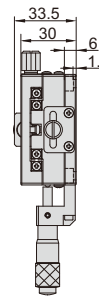
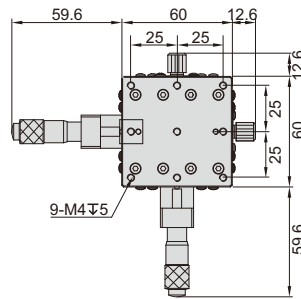

6584-903

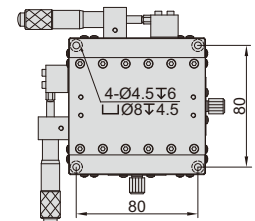
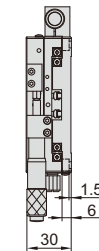
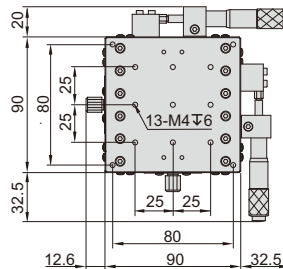

- Cross roller guides, achieve high precision and smooth movement
- Stages made of aluminum alloy

SPECIFICATION (micrometer on the left)

Code	XY-axis displacement	Parallelism of top to bottom surface	Micrometer graduation	Micrometer accuracy	Maximum load	Micrometer location	Stage size	Weight
6584-401	±6.5mm	0.04mm	0.01mm	0.01mm	29.4N (3kgf)	left	40x40mm	0.27kg
6584-601	±6.5mm	0.06mm	0.01mm	0.01mm	49N (5kgf)	left	60x60mm	0.48kg
6584-901	±12.5mm	0.06mm	0.01mm	0.02mm	93.1N (9.5kgf)	left	90x90mm	1kg
6584-1251	±12.5mm	0.08mm	0.01mm	0.02mm	180N (18.4kgf)	left	125x125mm	2.8kg

SPECIFICATION (micrometer in the middle)

Code	XY-axis displacement	Parallelism of top to bottom surface	Micrometer graduation	Micrometer accuracy	Maximum load	Micrometer location	Stage size	Weight
6584-402	±6.5mm	0.04mm	0.01mm	0.01mm	29.4N (3kgf)	middle	40x40mm	0.27kg
6584-602	±6.5mm	0.06mm	0.01mm	0.01mm	49N (5kgf)	middle	60x60mm	0.48kg
6584-902	±12.5mm	0.06mm	0.01mm	0.02mm	93.1N (9.5kgf)	middle	90x90mm	1kg
6584-1252	±12.5mm	0.08mm	0.01mm	0.02mm	180N (18.4kgf)	middle	125x125mm	2.8kg

SPECIFICATION (micrometer on the right)

Code	XY-axis displacement	Parallelism of top to bottom surface	Micrometer graduation	Micrometer accuracy	Maximum load	Micrometer location	Stage size	Weight
6584-403	±6.5mm	0.04mm	0.01mm	0.01mm	29.4N (3kgf)	right	40x40mm	0.27kg
6584-603	±6.5mm	0.06mm	0.01mm	0.01mm	49N (5kgf)	right	60x60mm	0.48kg
6584-903	±12.5mm	0.06mm	0.01mm	0.02mm	93.1N (9.5kgf)	right	90x90mm	1kg
6584-1253	±12.5mm	0.08mm	0.01mm	0.02mm	180N (18.4kgf)	right	125x125mm	2.8kg

**XZ-AXIS STAGE
CODE 6587-60**

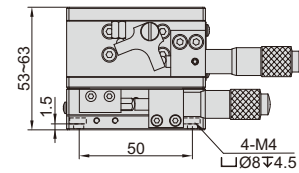
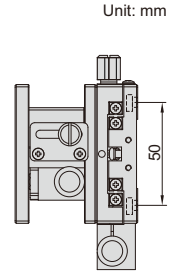
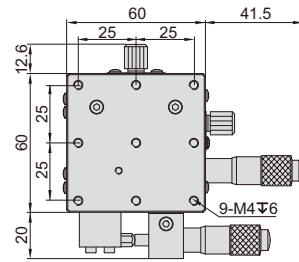

- Cross roller guides, achieve high precision and smooth movement
- Stage made of aluminum alloy

SPECIFICATION

Code	X-axis displacement	Z-axis displacement	Micrometer graduation	Maximum load	Stage size	Weight
6587-60	±6.5mm	10mm	0.01mm	29.4N (3kgf)	60x60mm	0.51kg

12

**XYZ-AXIS STAGE
CODE 6585-60**

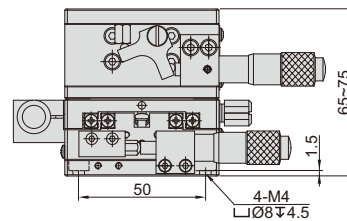
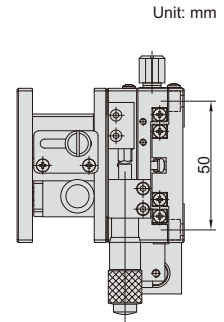
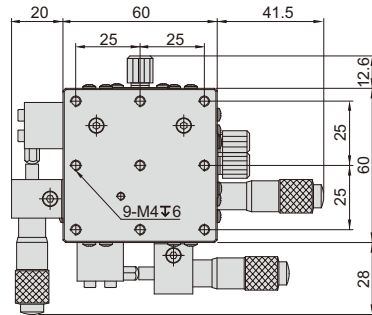
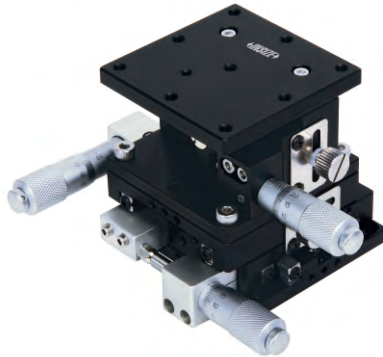

- Cross roller guides, achieve high precision and smooth movement
- Stage made of aluminum alloy

SPECIFICATION

Code	XY-axis displacement	Z-axis displacement	Micrometer graduation	Maximum load	Stage size	Weight
6585-60	±6.5mm	10mm	0.01mm	29.4N (3kgf)	60x60mm	0.75kg

ROTARY STAGES



6583-60H

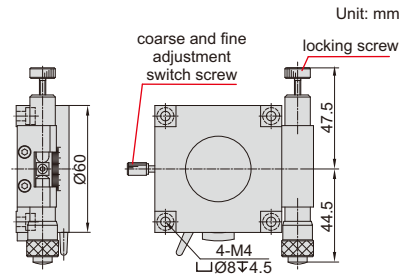
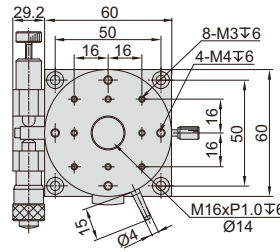

6583-90

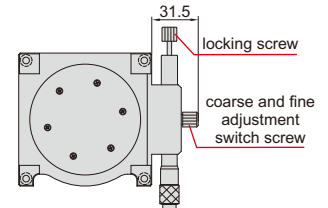
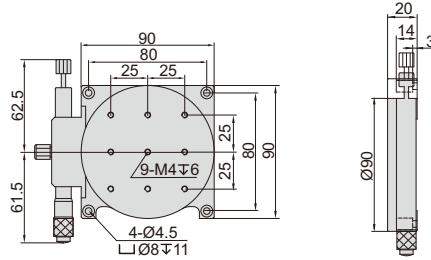

- Precise angle adjustment
- Coarse and fine adjustments
- Stages made of aluminum alloy

SPECIFICATION

Code	Range	Parallelism of top to bottom surface	Concentricity	Rotation accuracy	Maximum load	Stage size	Weight
6583-60H	360° coarse, ±5° fine	0.03mm	0.03mm	12'	29.4N (3kgf)	Ø60mm	0.30kg
6583-90	360° coarse, ±5° fine	0.04mm	0.03mm	5'	29.4N (3kgf)	Ø90mm	0.50kg

XY-AXIS ROTARY STAGE CODE 6588-60

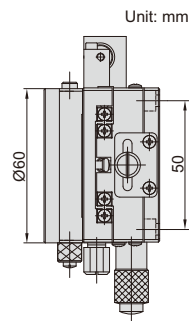
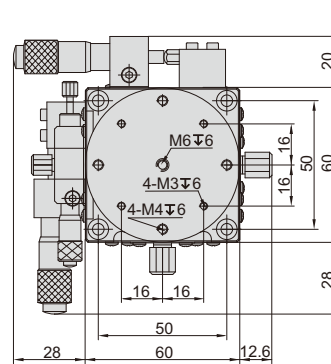

- Cross roller guides, achieve high precision and smooth movement
- Coarse and fine adjustments
- Precise angle adjustment
- Stage made of aluminum alloy

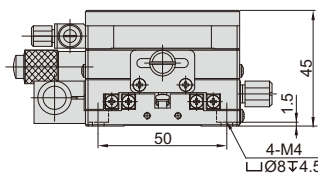

SPECIFICATION

Code	XY-axis displacement	Rotation range	Micrometer graduation	Rotation accuracy	Maximum load	Stage size	Weight
6588-60	±6.5mm	360° coarse, ±5° fine	0.01mm	10'	29.4N (3kgf)	60x60mm	0.64kg

PRECISION AIR FLOATING ROTARY TABLES

air filter (included)



6875-320

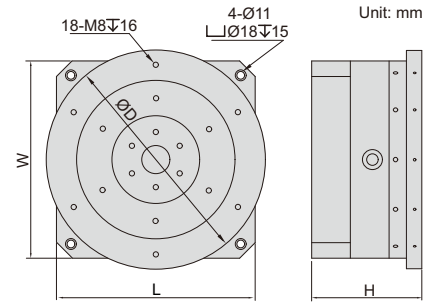

Unit: mm

- Manual rotation
- Optional accessory: high precision digital indicators (code 2133 series), hydraulic universal magnetic stands (code 6274 series)

Code	Stage size ØD	Max. RPM	Air supply pressure	Max. load	Radial stiffness	Axial stiffness	Radial runout	Axial runout	L×W×H
6875-320	320mm	500rpm	5-6bar	100kg	250N/μm	500N/μm	<0.3μm	<0.3μm	272x272x161mm
6875-400	400mm	500rpm	5-6bar	100kg	250N/μm	500N/μm	<0.3μm	<0.3μm	272x272x161mm
6875-500	500mm	500rpm	5-6bar	100kg	250N/μm	500N/μm	<0.3μm	<0.3μm	272x272x191mm

Standard glass hemisphere (optional)

Code	Roundness
6875-BALL*	0.05μm



6875-BALL

*To check the accuracy of rotary table

Clamp for glass hemisphere (optional)



6875-CLAMP



application

CENTERING INDICATOR

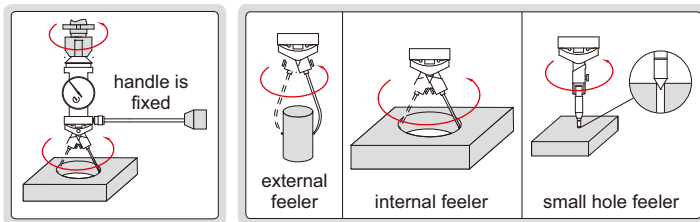

2385-3

- Provides quick and accurate centering in boring and milling set-up
- Maximum speed is recommended not to exceed 800RPM

Feeler	Measuring diameter	Accuracy
P1	Ø0-60mm	0.015mm
P2	Ø0-160mm	0.02mm
P3	Ø0-250mm	0.03mm
P4	Ø3.2-80mm	0.015mm
P5	Ø3.2-180mm	0.02mm
P6	Ø3.2-280mm	0.03mm
P7	Ø0-2.8mm	0.015mm

Code
2385-3

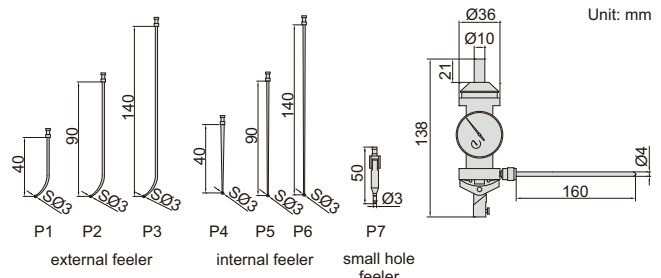

Unit: mm

3D ELECTRONIC EDGE FINDERS

INSIZE PLUS
MADE IN EUROPE

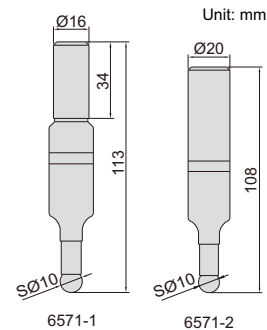
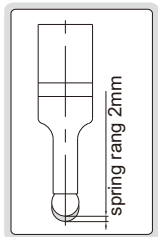

- The shank is electrically conducted to the metal workpiece through the chuck and table. The LED lights up, when the ball touches the workpiece
- Not suitable for rotary use
- Hardened contact ball

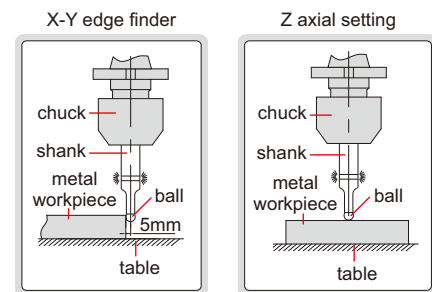

Code	Shank	Contact ball	Accuracy	Battery
6571-1	Ø16mm	SØ10mm	10µm	23A, 12Vx1 pc
6571-2	Ø20mm	SØ10mm	10µm	23A, 12Vx1 pc

12

LARGE SHANK ELECTRONIC EDGE FINDERS

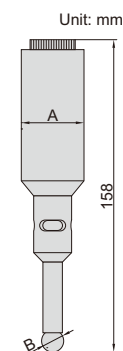

- The shank is electrically conducted to the metal workpiece through the chuck and table. The LED lights up and the beeper sounds (only for 6572-2), when the ball touches the workpiece
- Not suitable for rotary use
- Hardened shank and contact ball

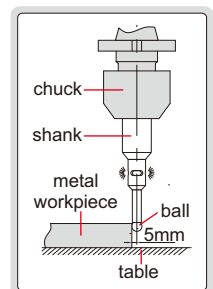

Code	Shank (A)	Contact ball (B)	Accuracy	Beeper	Battery
6572-1	Ø32mm	SØ10mm	5µm	without	23A, 12Vx1 pc
6572-2	Ø32mm	SØ10mm	5µm	with	23A, 12Vx1 pc

ELECTRONIC EDGE FINDERS

- The shank is electrically conducted to the metal workpiece through the chuck and table. The LED lights up and the beeper sounds (only for **6566-3**), when the ball touches the workpiece
- Not suitable for rotary use
- Hardened shank and contact ball

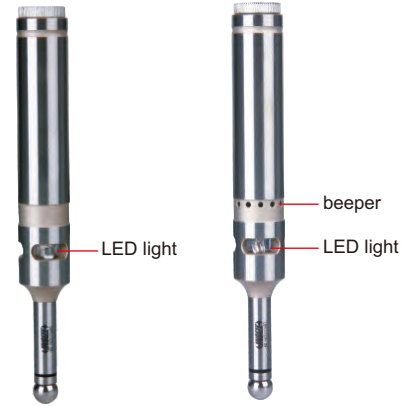
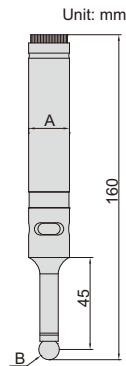
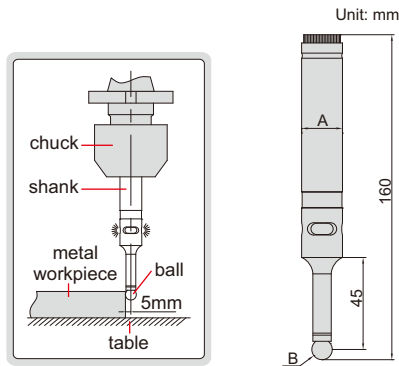

6566-2

6566-3

Code	Shank (A)	Contact ball (B)	Accuracy	Beeper	Battery
6566-2	Ø20mm	SØ10mm	5µm	without	23A, 12Vx1 pc
6566-3	Ø20mm	SØ10mm	5µm	with	23A, 12Vx1 pc

NON-MAGNETIC EDGE FINDERS

12

- TiAlN coating, non-magnetic, hardness HV2500, extremely wear resistance
- Suitable for machine speed 400~600rpm

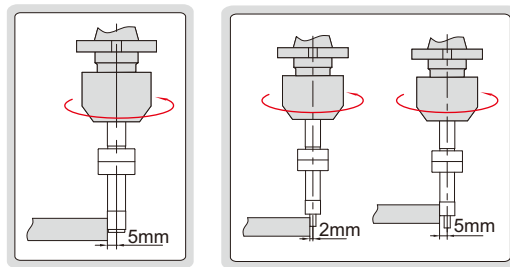

6573-1

6573-2

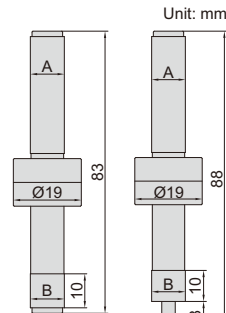

6573-1

6573-2



6573-1

6573-2

Code	Shank (A)	Contact point (B)	Contact point (C)	Accuracy
6573-1	Ø10mm	Ø10mm	—	5µm
6573-2	Ø10mm	Ø10mm	Ø4mm	5µm

EDGE FINDERS

- Hardened shank and contact point
- Suitable for machine speed 400~600rpm

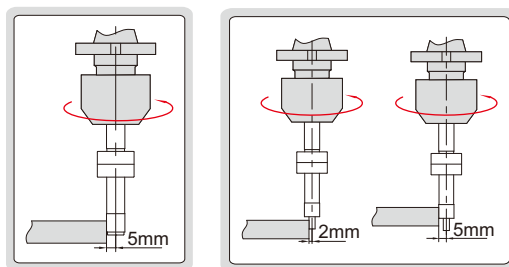

6562-3

6562-4

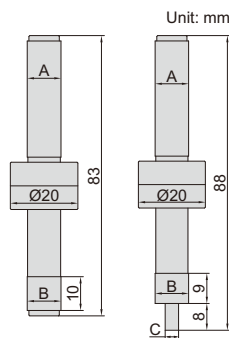

6562-3

6562-4



6562-3

6562-4

Code	Shank (A)	Contact point (B)	Contact point (C)	Accuracy
6562-3	Ø10mm	Ø10mm	—	5µm
6562-4	Ø10mm	Ø10mm	Ø4mm	5µm

EDGE FINDER

- Hardened shank and contact point
- Suitable for machine speed 400~600rpm

Code	Shank (A)	Contact point (B)	Accuracy
6567-1	Ø10mm	Ø6mm	8µm

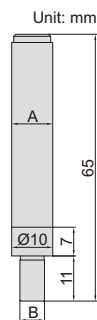

6567-1

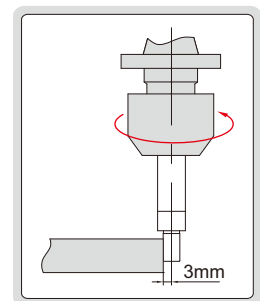

CERAMIC EDGE FINDER

- Ceramic contact point, non magnetic
- Suitable for machine speed 400~600rpm

Code	Shank (A)	Contact point (B)	Accuracy
6568-1	Ø10mm	Ø10mm	8µm

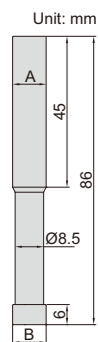

6568-1

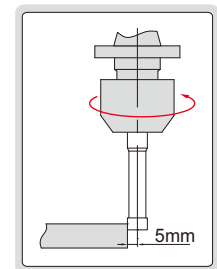

12

LOW TEST FORCE

ELECTRONIC ZERO SETTER

INSIZE PLUS
MADE IN EUROPE

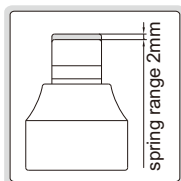

6553-50

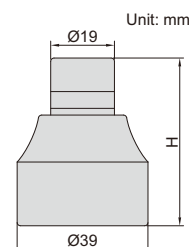

- The base is electrically conducted to the cutting tools through the table and chuck. The LED lights up when the cutting tool touches the anvil
- Magnetic base
- Two batteries LR44

Code	Height (H)	Accuracy	Test force
6553-50	50mm	±10µm	7N (at 49mm)

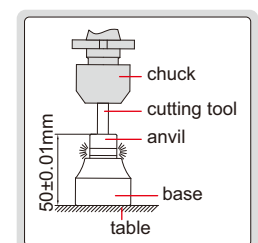

DIGITAL ZERO SETTER

IP65
WATERPROOF

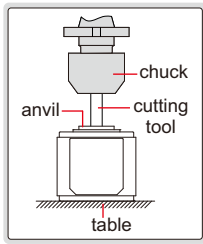

6557-50

Unit: mm

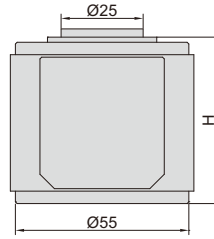

- Resolution: 0.001mm/0.00005"
- IP65 dust/waterproof
- Buttons: on/off, mm/inch, zero
- CR2032 battery
- Automatic power off
- Magnetic base
- Automatic backlight at zero

automatic backlight at zero



set zero



Code	Height (H)	Anvil stroke	Accuracy *	Test force	Repeatability
6557-50	50mm	2.5mm	±10µm/0.0004"	10N (at 50mm)	2µm

*The accuracy is ensured within Ø10mm of the center

12

ZERO SETTER

INSIZE PLUS
MADE IN EUROPE

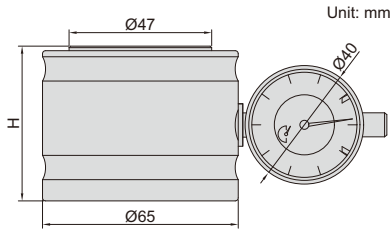

Unit: mm



6554-50

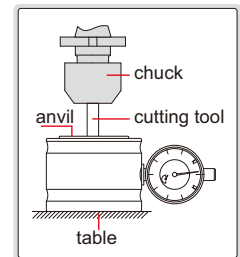

Code	Height (H)	Accuracy	Test force
6554-50	50mm	±10µm	9N (at 50mm)

ZERO SETTER

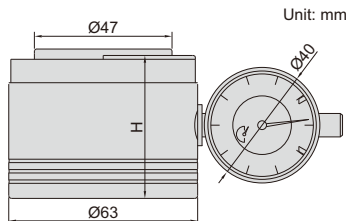
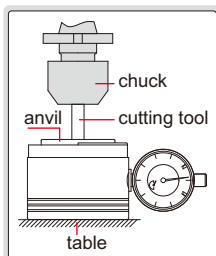

Unit: mm



6556-50

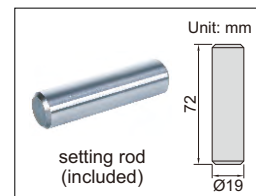

Code	Height (H)	Accuracy	Test force
6556-50	50mm	±10µm	10N (at 50mm)

ZERO SETTER

- Magnetic base

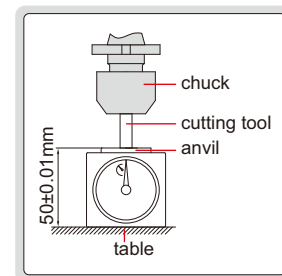
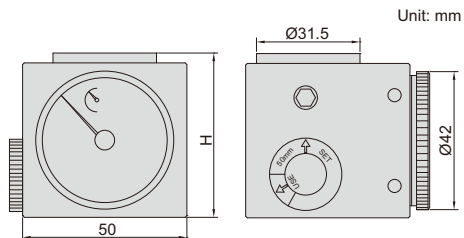

2397-502A

Code	Height (H)	Accuracy	Test force
2397-502A	50mm	±10µm	9N (at 50mm)

ZERO SETTER

- Magnetic base with on-off switch

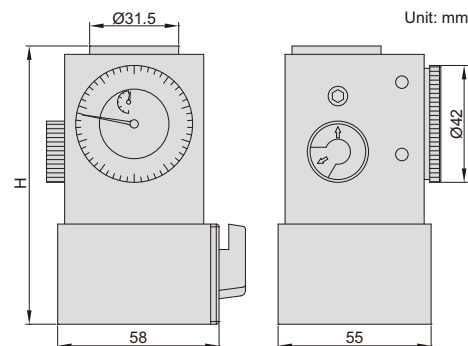
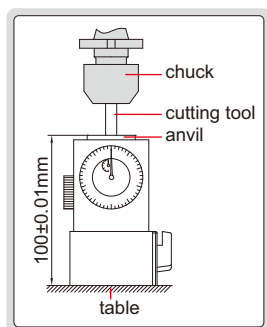

2394-100A

Code	Height (H)	Accuracy	Test force
2394-100A	100mm	±10µm	9N (at 100mm)

LOW TEST FORCE

LOW TEST FORCE ZERO SETTER

INSIZE PLUS
MADE IN EUROPE

- Magnetic base
- Low test force, suitable for micro tools with minimum diameter Ø0.1mm

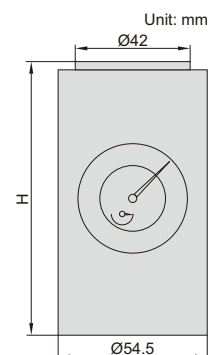
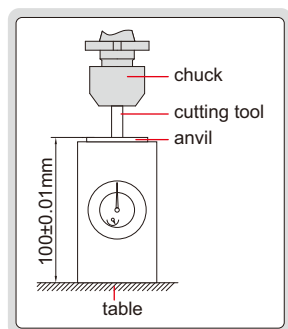

6555-100B

Code	Height (H)	Accuracy	Test force
6555-100B	100mm	±10µm	1N (at 100mm)