

WIRELESS DIGITAL CALIPERS

ATTENTION: THE WORKING LIFE OF A BATTERY IS ABOUT 3-5 MONTHS

INSPECTION CERTIFICATE
TRACEABLE TO DKD

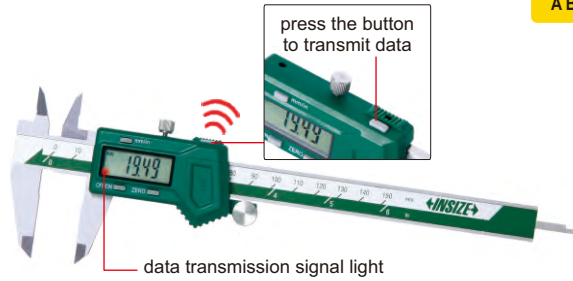
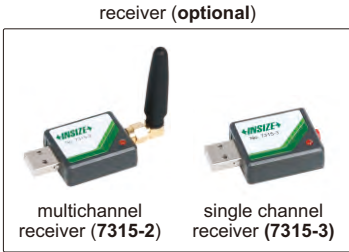

1113-150

- Built-in wireless data transmission module, Zigbee signal
- Transmission distance is 10 meter (under the condition of no obstruction and no electromagnetic interference)
- Resolution: 0.01mm/0.0005"
- Buttons: on/off, zero, mm/inch, data transmission
- Automatic power off, move the digital unit to turn on power
- Battery CR2032
- Made of stainless steel
- Optional accessory: receiver (code 7315-2/3/6/7/8)

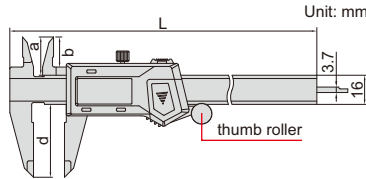

Code	Range	Accuracy	Thumb roller	L	a	b	d
1113-150*	0-150mm/0-6"	±0.03mm	with	236	21	16	40
1113-200*	0-200mm/0-8"	±0.03mm	with	286	24	19	50
1113-300*	0-300mm/0-12"	±0.03mm	with	400	25	20.5	60
1113-150W*	0-150mm/0-6"	±0.03mm	without	236	21	16	40
1113-200W*	0-200mm/0-8"	±0.03mm	without	286	24	19	50
1113-300W*	0-300mm/0-12"	±0.03mm	without	400	25	20.5	60

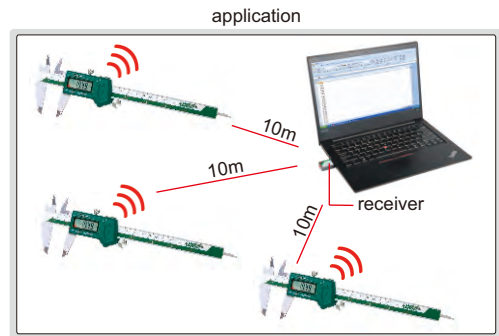

*Supplied with manufacturer inspection certificate traceable to DKD Germany

IP67 WATERPROOF DIGITAL CALIPERS

ATTENTION: IT IS NECESSARY TO SET ZERO AFTER POWER ON EACH TIME

ATTENTION: NO DATA OUTPUT

IP67 WATERPROOF

INSPECTION CERTIFICATE
TRACEABLE TO DKD



1118-150B

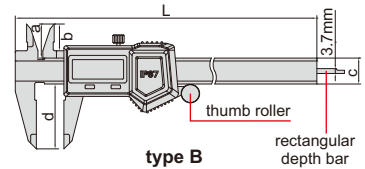

type B

- IP67 dust/waterproof
- Resolution: 0.01mm/0.0005"
- Button function: zero, on/off, mm/inch, ABS/REL, hold
- Battery CR2032
- Meet DIN862
- Made of stainless steel



1118-150R

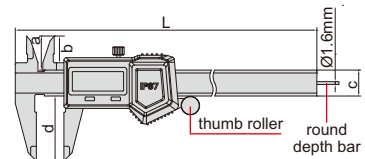

type R

Code	Range	Accuracy	Thumb roller	Type	L	a	b	c	d
1118-150B*	0-150mm/0-6"	±0.03mm	with	B	236mm	21mm	16mm	16mm	40mm
1118-200B*	0-200mm/0-8"	±0.03mm	with	B	286mm	24mm	19mm	16mm	50mm
1118-300B*	0-300mm/0-12"	±0.03mm	with	B	400mm	25mm	20.5mm	16mm	60mm
1118-150BW*	0-150mm/0-6"	±0.03mm	without	B	236mm	21mm	16mm	16mm	40mm
1118-200BW*	0-200mm/0-8"	±0.03mm	without	B	286mm	24mm	19mm	16mm	50mm
1118-300BW*	0-300mm/0-12"	±0.03mm	without	B	400mm	25mm	20.5mm	16mm	60mm
1118-150R*	0-150mm/0-6"	±0.03mm	with	R	236mm	21mm	16mm	16mm	40mm
1118-150RW*	0-150mm/0-6"	±0.03mm	without	R	236mm	21mm	16mm	16mm	40mm

*Supplied with manufacturer inspection certificate traceable to DKD Germany

INSPECTION CERTIFICATE
TRACEABLE TO DKD

ATTENTION: WHEN POWER ON 8 HOURS AFTER SHUTDOWN, IT IS NECESSARY TO SET ZERO

IP67 WATERPROOF DIGITAL CALIPERS

ATTENTION:
NO DATA OUTPUT

IP67
WATERPROOF

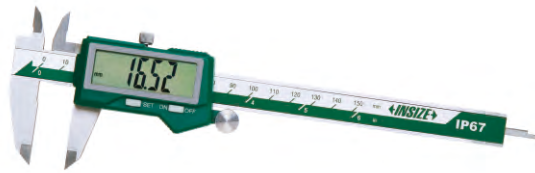

1126-150

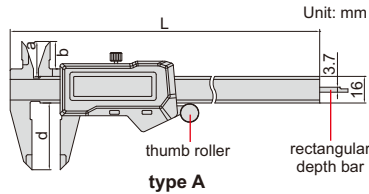

1126-150R

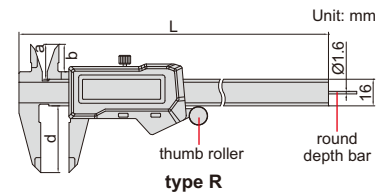

- IP67 dust/waterproof
- Resolution: 0.01mm/0.0005"
- Large display
- Button function: zero, on/off, mm/inch
- Battery CR2032
- Automatic power off
- Meet DIN862
- Made of stainless steel

Code	Range	Accuracy	Thumb roller	Type	L	a	b	d
1126-150 *	0-150mm/0-6"	±0.03mm	with	A	234	20	15	40
1126-200 *	0-200mm/0-8"	±0.03mm	with	A	286	24	19	50
1126-300 *	0-300mm/0-12"	±0.03mm	with	A	390	26	21.5	60
1126-150W *	0-150mm/0-6"	±0.03mm	without	A	234	20	15	40
1126-200W *	0-200mm/0-8"	±0.03mm	without	A	286	24	19	50
1126-300W *	0-300mm/0-12"	±0.03mm	without	A	390	26	21.5	60
1126-150R *	0-150mm/0-6"	±0.03mm	with	R	234	20	15	40
1126-150RW *	0-150mm/0-6"	±0.03mm	without	R	234	20	15	40

* Supplied with manufacturer inspection certificate traceable to DKD Germany

ATTENTION: WHEN POWER ON 8 HOURS AFTER SHUTDOWN, IT IS NECESSARY TO SET ZERO

ATTENTION: THE WORKING LIFE OF A BATTERY IS ABOUT 4-6 MONTHS

INSPECTION CERTIFICATE
TRACEABLE TO DKD

BLUETOOTH

IP67
WATERPROOF

BUILT-IN BLUETOOTH IP67 WATERPROOF DIGITAL CALIPERS

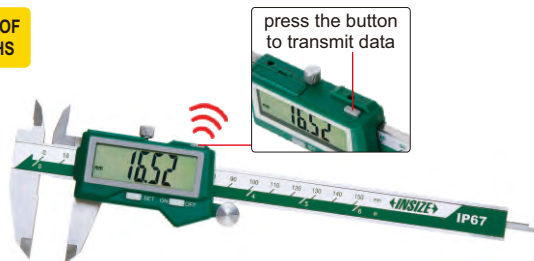

1127-150

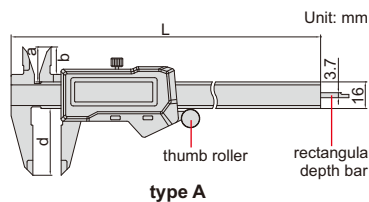

1127-150R

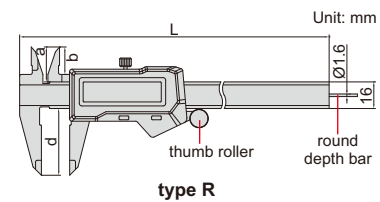

- Built-in bluetooth 4.0 wireless transmission module, connect with computers (with bluetooth receiver), mobile phones, tablets, etc., and output keyboard signals (under the condition of no obstruction and no electromagnetic interference)
- IP67 dust/waterproof
- Resolution: 0.01mm/0.0005"
- Large display
- Button function: zero, on/off, mm/inch, data transmission
- Battery CR2032, automatic power off
- Meet DIN862
- Made of stainless steel

Code	Range	Accuracy	Thumb roller	Type	L	a	b	d
1127-150 *	0-150mm/0-6"	±0.03mm	with	A	234	20	15	40
1127-200 *	0-200mm/0-8"	±0.03mm	with	A	286	24	19	50
1127-300 *	0-300mm/0-12"	±0.03mm	with	A	390	26	21.5	60
1127-150W *	0-150mm/0-6"	±0.03mm	without	A	234	20	15	40
1127-200W *	0-200mm/0-8"	±0.03mm	without	A	286	24	19	50
1127-300W *	0-300mm/0-12"	±0.03mm	without	A	390	26	21.5	60
1127-150R *	0-150mm/0-6"	±0.03mm	with	R	234	20	15	40
1127-150RW *	0-150mm/0-6"	±0.03mm	without	R	234	20	15	40

* Supplied with manufacturer inspection certificate traceable to DKD Germany

IP54 WATERPROOF DIGITAL CALIPERS

DATA OUTPUT

IP54 WATERPROOF

INSPECTION CERTIFICATE TRACEABLE TO DKD



1104-150

- IP54 dust/waterproof
- Resolution: 0.01mm/0.0005"
- Buttons: on/off, zero, mm/inch, ABS/REL
- Automatic power off
- Battery CR2032
- Data output
- Meet DIN862
- Made of stainless steel
- Optional accessory: wireless transmitter, code **7315-1104**, data output cable (keyboard format), code **7302-1104**

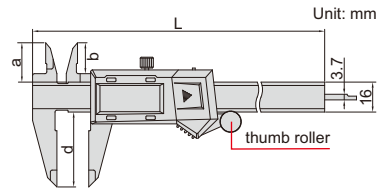

Code	Range	Accuracy	Thumb roller	L	a	b	d
1104-150 *	0-150mm/0-6"	±0.03mm	with	234mm	20mm	15mm	40mm
1104-200 *	0-200mm/0-8"	±0.03mm	with	286mm	24mm	19mm	50mm
1104-300 *	0-300mm/0-12"	±0.03mm	with	390mm	26mm	21.5mm	60mm
1104-150W *	0-150mm/0-6"	±0.03mm	without	234mm	20mm	15mm	40mm
1104-200W *	0-200mm/0-8"	±0.03mm	without	286mm	24mm	19mm	50mm
1104-300W *	0-300mm/0-12"	±0.03mm	without	390mm	26mm	21.5mm	60mm

*Supplied with manufacturer inspection certificate traceable to DKD Germany

DIGITAL CALIPERS (ABSOLUTE SYSTEM)

DATA OUTPUT

INSPECTION CERTIFICATE TRACEABLE TO DKD



1103-150

- Absolute system, low power consumption, long battery life
- Resolution: 0.01mm/0.0005"
- Buttons: on/off, mm/inch, ORIGIN, ZERO/ABS
- Automatic power off, move the digital unit to turn on power
- Battery CR2032
- Data output
- Meet DIN862
- Made of stainless steel
- Optional accessory: wireless transmitter, code **7315-1103**, data output cable (keyboard format), code **7302-1103**

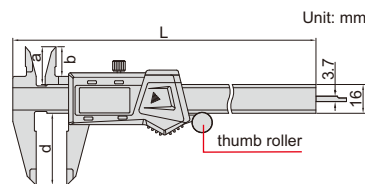

Code	Range	Accuracy	Thumb roller	L	a	b	d
1103-150 *	0-150mm/0-6"	±0.03mm	with	236mm	21mm	16.5mm	40mm
1103-200 *	0-200mm/0-8"	±0.03mm	with	286mm	24mm	19.5mm	50mm
1103-300 *	0-300mm/0-12"	±0.03mm	with	400mm	26mm	21.5mm	60mm
1103-150W *	0-150mm/0-6"	±0.03mm	without	236mm	21mm	16.5mm	40mm
1103-200W *	0-200mm/0-8"	±0.03mm	without	286mm	24mm	19.5mm	50mm
1103-300W *	0-300mm/0-12"	±0.03mm	without	400mm	26mm	21.5mm	60mm

*Supplied with manufacturer inspection certificate traceable to DKD Germany

INSPECTION CERTIFICATE
TRACEABLE TO DKD

ATTENTION:
NO DATA OUTPUT

DIGITAL CALIPERS (FRACTION READING)

- Resolution: 0.01mm, 0.0005", 1/128"
- Buttons: unit (mm/in/fraction), ABS, on/off, zero
- Absolute and incremental measurement
- Battery CR2032, automatic power off
- Meet DIN862
- Made of stainless steel

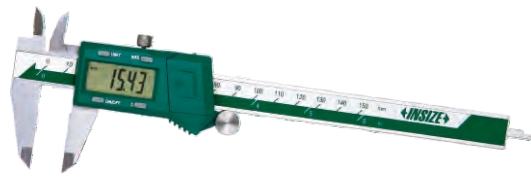

1102-150



fraction reading

Code	Range	Accuracy	Thumb roller	L	a	b	d
1102-150 *	0-150mm/0-6"	±0.03mm	with	234mm	20mm	15mm	40mm
1102-200 *	0-200mm/0-8"	±0.03mm	with	286mm	24mm	19mm	50mm
1102-300 *	0-300mm/0-12"	±0.03mm	with	390mm	26mm	21.5mm	60mm
1102-150W *	0-150mm/0-6"	±0.03mm	without	234mm	20mm	15mm	40mm
1102-200W *	0-200mm/0-8"	±0.03mm	without	286mm	24mm	19mm	50mm
1102-300W *	0-300mm/0-12"	±0.03mm	without	390mm	26mm	21.5mm	60mm

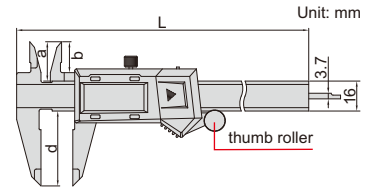

*Supplied with manufacturer inspection certificate traceable to DKD Germany

INSPECTION CERTIFICATE
TRACEABLE TO DKD

ATTENTION:
NO DATA OUTPUT

DIGITAL CALIPERS

- Zinc alloy housing for digital unit
- Resolution: 0.01mm/0.0005"
- Buttons: zero, on/off, mm/inch
- Automatic power off, move the digital unit to turn on power
- Battery CR2032
- Meet DIN862
- Made of stainless steel

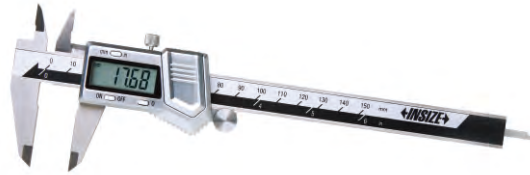

1114-150A

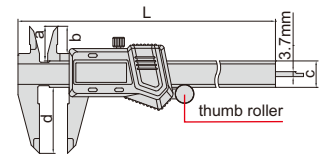

Code	Range	Accuracy	Thumb roller	L	a	b	c	d
1114-150A *	0-150mm/0-6"	±0.03mm	with	236mm	21mm	16mm	16mm	40mm
1114-200A *	0-200mm/0-8"	±0.03mm	with	286mm	24mm	19mm	16mm	50mm
1114-300A *	0-300mm/0-12"	±0.03mm	with	400mm	25mm	20.5mm	17mm	60mm
1114-150AW *	0-150mm/0-6"	±0.03mm	without	236mm	21mm	16mm	16mm	40mm
1114-200AW *	0-200mm/0-8"	±0.03mm	without	286mm	24mm	19mm	16mm	50mm
1114-300AW *	0-300mm/0-12"	±0.03mm	without	400mm	25mm	20.5mm	17mm	60mm

*Supplied with manufacturer inspection certificate traceable to DKD Germany

INSPECTION CERTIFICATE
TRACEABLE TO DKD

DATA OUTPUT

DIGITAL CALIPERS (STANDARD TYPE)

- Resolution: 0.01mm/0.0005"
- Buttons: on/off, zero, mm/inch
- Automatic power off, move the digital unit to turn on power
- Battery CR2032
- Data output
- Meet DIN862
- Made of stainless steel
- Optional accessory: data output cable (code 7315-21, 7302-21)



1108-150

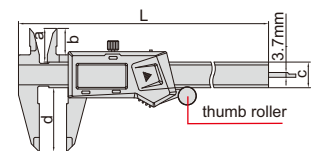

Code	Range	Accuracy	Thumb roller	L	a	b	c	d
1108-150 *	0-150mm/0-6"	±0.02mm	with	236mm	21mm	16mm	16mm	40mm
1108-200 *	0-200mm/0-8"	±0.03mm	with	286mm	24mm	19mm	16mm	50mm
1108-250 *	0-250mm/0-10"	±0.03mm	with	350mm	25mm	20.5mm	16mm	60mm
1108-300 *	0-300mm/0-12"	±0.03mm	with	400mm	25mm	20.5mm	16mm	60mm
1108-150W *	0-150mm/0-6"	±0.02mm	without	236mm	21mm	16mm	16mm	40mm
1108-200W *	0-200mm/0-8"	±0.03mm	without	286mm	24mm	19mm	16mm	50mm
1108-300W *	0-300mm/0-12"	±0.03mm	without	400mm	25mm	20.5mm	16mm	60mm

*Supplied with manufacturer inspection certificate traceable to DKD Germany

HEAVY DUTY 300mm DIGITAL CALIPERS

DATA OUTPUT

INSPECTION CERTIFICATE
TRACEABLE TO DKD

- Resolution: 0.01mm/0.0005"
- Buttons: on/off, zero, mm/inch
- Automatic power off, move the digital unit to turn on power
- Battery CR2032
- Data output
- Meet DIN862
- Made of stainless steel
- Optional accessory: data output cable (code 7315-22, 7302-22)



1196-300

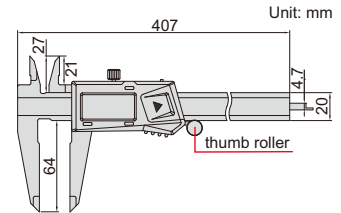

Code	Range	Thumb roller	Accuracy
1196-300 *	0-300mm/0-12"	with	±0.03mm
1196-300W *	0-300mm/0-12"	without	±0.03mm

*Supplied with manufacturer inspection certificate traceable to DKD Germany

METRIC DIGITAL CALIPERS

LOCK READING WITH "HOLD" BUTTON

DATA OUTPUT

INSPECTION CERTIFICATE
TRACEABLE TO DKD

- Resolution: 0.01mm
- Buttons: on/off, zero, hold
- Automatic power off, move the digital unit to turn on power
- Battery CR2032
- Data output
- Meet DIN862
- Made of stainless steel
- Optional accessory: data output cable (code 7315-21, 7302-21)



1109-150

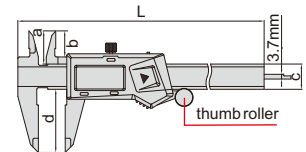

Code	Range	Accuracy	Thumb roller	L	a	b	c	d
1109-150 *	0-150mm	±0.03mm	with	236mm	21mm	16mm	16mm	40mm
1109-200 *	0-200mm	±0.03mm	with	286mm	24mm	19mm	16mm	50mm
1109-300 *	0-300mm	±0.03mm	with	400mm	25mm	20.5mm	16mm	60mm
1109-150W *	0-150mm	±0.03mm	without	236mm	21mm	16mm	16mm	40mm
1109-200W *	0-200mm	±0.03mm	without	286mm	24mm	19mm	16mm	50mm
1109-300W *	0-300mm	±0.03mm	without	400mm	25mm	20.5mm	16mm	60mm

*Supplied with manufacturer inspection certificate traceable to DKD Germany

DIGITAL CALIPERS WITH ROUND DEPTH BAR

DATA OUTPUT

INSPECTION CERTIFICATE
TRACEABLE TO DKD

- Resolution: 0.01mm/0.0005"
- Buttons: on/off, zero, mm/inch
- Automatic power off, move the digital unit to turn on power
- Battery CR2032
- Meet DIN862
- Made of stainless steel



1119-150



round depth bar Ø1.6mm

With data interface (data output cable code 7315-21, 7302-21, optional)

Code	Range	Accuracy	Thumb roller	L	a	b	c	d
1119-150 *	0-150mm/0-6"	±0.03mm	with	236mm	21mm	16mm	16mm	40mm
1119-150W *	0-150mm/0-6"	±0.03mm	without	236mm	21mm	16mm	16mm	40mm

Built-in wireless (receiver code 7315-2/3/6/7/8 is required)

Code	Range	Accuracy	Thumb roller	L	a	b	c	d
1119-150WL *	0-150mm/0-6"	±0.03mm	with	236mm	21mm	16mm	16mm	40mm
1119-150WWL *	0-150mm/0-6"	±0.03mm	without	236mm	21mm	16mm	16mm	40mm

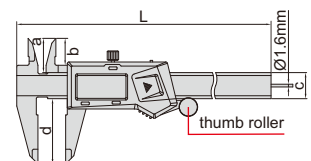

*Supplied with manufacturer inspection certificate traceable to DKD Germany

LEFT HAND DIGITAL CALIPERS

- Designed for left handed users
- Resolution: 0.01mm/0.0005"
- Buttons: on/off, zero, mm/inch
- Automatic power off, move the digital unit to turn on power
- Battery CR2032
- Data output
- Meet DIN862
- Made of stainless steel
- Optional accessory: data output cable (code 7315-22, 7302-22)



1130-150

Code	Range	Accuracy	Thumb roller	L	a	b	d
1130-150*	0-150mm/0-6"	±0.03mm	with	236mm	21mm	16mm	40mm
1130-200*	0-200mm/0-8"	±0.03mm	with	286mm	24mm	19mm	50mm
1130-300*	0-300mm/0-12"	±0.03mm	with	400mm	25mm	20.5mm	60mm
1130-150W*	0-150mm/0-6"	±0.03mm	without	236mm	21mm	16mm	40mm
1130-200W*	0-200mm/0-8"	±0.03mm	without	286mm	24mm	19mm	50mm
1130-300W*	0-300mm/0-12"	±0.03mm	without	400mm	25mm	20.5mm	60mm

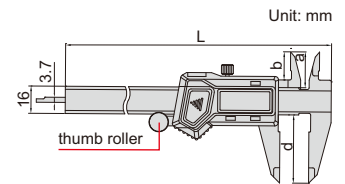

*Supplied with manufacturer inspection certificate traceable to DKD Germany

DIGITAL CALIPERS WITH CERAMIC TIPPED JAWS

- Ceramic tipped jaws for outside measurement, extremely wear-resistant, non-magnetic and non electric conductive
- Resolution: 0.01mm/0.0005"
- Buttons: on/off, zero, mm/inch
- Automatic power off, move the digital unit to turn on power
- Battery CR2032, made of stainless steel
- Meet DIN862



1193-150

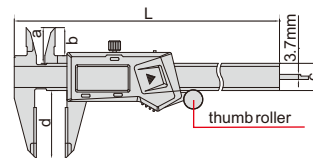

ceramic tipped jaws



With data interface (data output cable code 7315-21, 7302-21, optional)

Code	Range	Accuracy	Thumb roller	L	a	b	c	d
1193-150*	0-150mm/0-6"	±0.03mm	with	235mm	21mm	16.5mm	16mm	40mm
1193-200*	0-200mm/0-8"	±0.03mm	with	287mm	24mm	20mm	16mm	50mm
1193-300*	0-300mm/0-12"	±0.03mm	with	390mm	26mm	21.5mm	16mm	60mm
1193-150W*	0-150mm/0-6"	±0.03mm	without	235mm	21mm	16.5mm	16mm	40mm
1193-200W*	0-200mm/0-8"	±0.03mm	without	297mm	24mm	20mm	16mm	50mm
1193-300W*	0-300mm/0-12"	±0.03mm	without	390mm	26mm	21.5mm	16mm	60mm

Built-in wireless (receiver code 7315-2/3/6/7/8 is required)

Code	Range	Accuracy	Thumb roller	L	a	b	c	d
1193-150WL*	0-150mm/0-6"	±0.03mm	with	235mm	21mm	16.5mm	16mm	40mm
1193-200WL*	0-200mm/0-8"	±0.03mm	with	287mm	24mm	20mm	16mm	50mm
1193-300WL*	0-300mm/0-12"	±0.03mm	with	390mm	26mm	21.5mm	16mm	60mm
1193-150WWL*	0-150mm/0-6"	±0.03mm	without	235mm	21mm	16.5mm	16mm	40mm
1193-200WWL*	0-200mm/0-8"	±0.03mm	without	297mm	24mm	20mm	16mm	50mm
1193-300WWL*	0-300mm/0-12"	±0.03mm	without	390mm	26mm	21.5mm	16mm	60mm

*Supplied with manufacturer inspection certificate traceable to DKD Germany

DIGITAL CALIPERS WITH CARBIDE TIPPED JAWS

carbide measuring faces



carbide measuring faces

1110-150A

steel measuring faces



carbide measuring faces

1110-150B

- Resolution: 0.01mm/0.0005"
- Buttons: on/off, zero, mm/inch
- Automatic power off, move the digital unit to turn on power
- Battery CR2032
- Meet DIN862
- Made of stainless steel

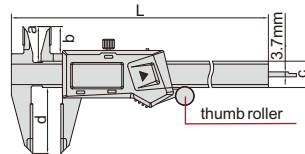

carbide measuring faces



carbide measuring faces

1110-150C

No dust/waterproof, with data interface (data output cable code 7315-21, 7302-21, optional)

Code	Range	Accuracy	Thumb roller	L	a	b	c	d	Remark
1110-150A *	0-150mm/0-6"	±0.03mm	with	236mm	21mm	16mm	16mm	40mm	carbide tipped upper and lower jaws
1110-200A *	0-200mm/0-8"	±0.03mm	with	286mm	24mm	19mm	16mm	50mm	carbide tipped upper and lower jaws
1110-300A *	0-300mm/0-12"	±0.03mm	with	400mm	25mm	20.5mm	16mm	60mm	carbide tipped upper and lower jaws
1110-150AW *	0-150mm/0-6"	±0.03mm	without	236mm	21mm	16mm	16mm	40mm	carbide tipped upper and lower jaws
1110-200AW *	0-200mm/0-8"	±0.03mm	without	286mm	24mm	19mm	16mm	50mm	carbide tipped upper and lower jaws
1110-300AW *	0-300mm/0-12"	±0.03mm	without	400mm	25mm	20.5mm	16mm	60mm	carbide tipped upper and lower jaws
1110-150B *	0-150mm/0-6"	±0.03mm	with	236mm	21mm	16mm	16mm	40mm	carbide tipped lower jaws
1110-200B *	0-200mm/0-8"	±0.03mm	with	286mm	24mm	19mm	16mm	50mm	carbide tipped lower jaws
1110-300B *	0-300mm/0-12"	±0.03mm	with	400mm	25mm	20.5mm	16mm	60mm	carbide tipped lower jaws
1110-150BW *	0-150mm/0-6"	±0.03mm	without	236mm	21mm	16mm	16mm	40mm	carbide tipped lower jaws
1110-200BW *	0-200mm/0-8"	±0.03mm	without	286mm	24mm	19mm	16mm	50mm	carbide tipped lower jaws
1110-300BW *	0-300mm/0-12"	±0.03mm	without	400mm	25mm	20.5mm	16mm	60mm	carbide tipped lower jaws

No dust/waterproof, built-in wireless (receiver code 7315-2/3/6/7/8 is required)

Code	Range	Accuracy	Thumb roller	L	a	b	c	d	Remark
1110-150AWL *	0-150mm/0-6"	±0.03mm	with	236mm	21mm	16mm	16mm	40mm	carbide tipped upper and lower jaws
1110-200AWL *	0-200mm/0-8"	±0.03mm	with	286mm	24mm	19mm	16mm	50mm	carbide tipped upper and lower jaws
1110-300AWL *	0-300mm/0-12"	±0.03mm	with	400mm	25mm	20.5mm	16mm	60mm	carbide tipped upper and lower jaws
1110-150AWWL *	0-150mm/0-6"	±0.03mm	without	236mm	21mm	16mm	16mm	40mm	carbide tipped upper and lower jaws
1110-200AWWL *	0-200mm/0-8"	±0.03mm	without	286mm	24mm	19mm	16mm	50mm	carbide tipped upper and lower jaws
1110-300AWWL *	0-300mm/0-12"	±0.03mm	without	400mm	25mm	20.5mm	16mm	60mm	carbide tipped upper and lower jaws
1110-150BWL *	0-150mm/0-6"	±0.03mm	with	236mm	21mm	16mm	16mm	40mm	carbide tipped lower jaws
1110-200BWL *	0-200mm/0-8"	±0.03mm	with	286mm	24mm	19mm	16mm	50mm	carbide tipped lower jaws
1110-300BWL *	0-300mm/0-12"	±0.03mm	with	400mm	25mm	20.5mm	16mm	60mm	carbide tipped lower jaws
1110-150BWWL *	0-150mm/0-6"	±0.03mm	without	236mm	21mm	16mm	16mm	40mm	carbide tipped lower jaws
1110-200BWWL *	0-200mm/0-8"	±0.03mm	without	286mm	24mm	19mm	16mm	50mm	carbide tipped lower jaws
1110-300BWWL *	0-300mm/0-12"	±0.03mm	without	400mm	25mm	20.5mm	16mm	60mm	carbide tipped lower jaws

IP67 dust/waterproof, without data interface

Code	Range	Accuracy	Thumb roller	L	a	b	c	d	Remark
1110-150C *	0-150mm/0-6"	±0.03mm	with	236mm	21mm	16mm	16mm	40mm	carbide tipped upper and lower jaws
1110-150D *	0-150mm/0-6"	±0.03mm	with	236mm	21mm	16mm	16mm	40mm	carbide tipped lower jaws
1110-150CW *	0-150mm/0-6"	±0.03mm	without	236mm	21mm	16mm	16mm	40mm	carbide tipped upper and lower jaws
1110-150DW *	0-150mm/0-6"	±0.03mm	without	236mm	21mm	16mm	16mm	40mm	carbide tipped lower jaws

* Supplied with manufacturer inspection certificate traceable to DKD Germany

DATA OUTPUT

DIGITAL CALIPERS

- Resolution: 0.01mm/0.0005"
- Buttons: on/off, zero, mm/inch
- Automatic power off, move the digital unit to turn on power
- Battery CR2032
- Made of stainless steel



1170-300

With data interface (data output cable code 7315-21, 7302-21, optional)

Code	Range	Accuracy	a	c	d	e	L
1170-200	0-200mm/0-8"	±0.03mm	12mm	17mm	60mm	10mm	314mm
1170-306	0-300mm/0-12"	±0.04mm	12mm	17mm	60mm	10mm	420mm
1170-300	0-300mm/0-12"	±0.06mm	12mm	17mm	90mm	10mm	420mm

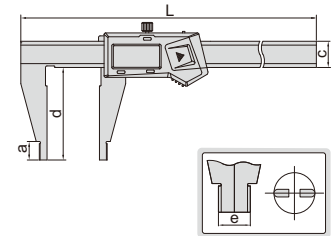

Built-in wireless (receiver code 7315-2/3/6/7/8 is required)

Code	Range	Accuracy	a	c	d	e	L
1170-200WL	0-200mm/0-8"	±0.03mm	12mm	17mm	60mm	10mm	314mm
1170-306WL	0-300mm/0-12"	±0.04mm	12mm	17mm	60mm	10mm	420mm
1170-300WL	0-300mm/0-12"	±0.06mm	12mm	17mm	90mm	10mm	420mm

DATA OUTPUT

DIGITAL CALIPERS

- Resolution: 0.01mm/0.0005"
- Buttons: on/off, zero, mm/inch
- Automatic power off, move the digital unit to turn on power
- Battery CR2032
- Made of stainless steel

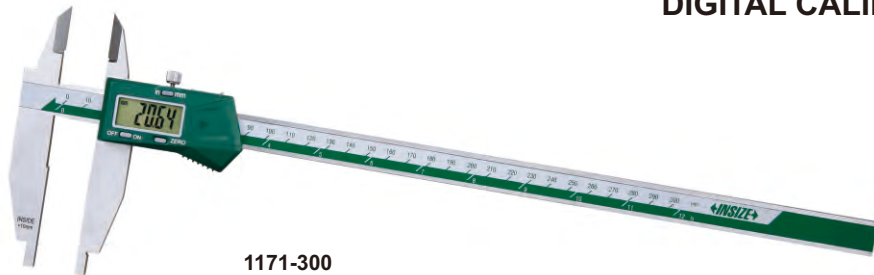

1171-300

With data interface (data output cable code 7315-21, 7302-21, optional)

Code	Range	Accuracy	a	b	c	d	e	L
1171-200	0-200mm/0-8"	±0.03mm	12mm	38mm	17mm	60mm	10mm	320mm
1171-250	0-250mm/0-10"	±0.03mm	12mm	38mm	17mm	60mm	10mm	365mm
1171-306	0-300mm/0-12"	±0.04mm	12mm	38mm	17mm	60mm	10mm	420mm
1171-300	0-300mm/0-12"	±0.06mm	12mm	38mm	17mm	90mm	10mm	420mm

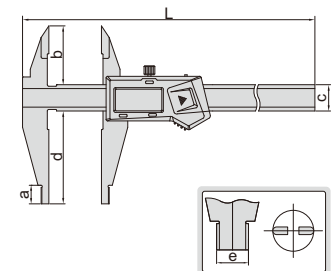

Built-in wireless (receiver code 7315-2/3/6/7/8 is required)

Code	Range	Accuracy	a	b	c	d	e	L
1171-200WL	0-200mm/0-8"	±0.03mm	12mm	38mm	17mm	60mm	10mm	320mm
1171-250WL	0-250mm/0-10"	±0.03mm	12mm	38mm	17mm	60mm	10mm	365mm
1171-306WL	0-300mm/0-12"	±0.04mm	12mm	38mm	17mm	60mm	10mm	420mm
1171-300WL	0-300mm/0-12"	±0.06mm	12mm	38mm	17mm	90mm	10mm	420mm

MINI DIGITAL CALIPERS

ATTENTION: NO DATA OUTPUT

- Resolution: 0.01mm/0.0005"
- Buttons: zero, mm/inch, on/off
- Automatic power off, move the digital unit to turn on power
- Battery LR44
- Meet DIN862
- Made of stainless steel



1111-100A

Code	Range	Accuracy	L
1111-75A	0-75mm/0-3"	±0.02mm	144mm
1111-100A	0-100mm/0-4"	±0.02mm	170mm

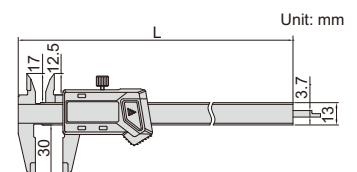

PLASTIC DIGITAL CALIPER

- Made of hard plastic, non-magnetic and non electric conductive
- Prevent workpieces from scratching by calipers
- Resolution: 0.01mm/0.0005"
- Buttons: on/off, zero, mm/inch
- Battery CR2032, automatic power off

ATTENTION:
NO DATA OUTPUT



1139-150

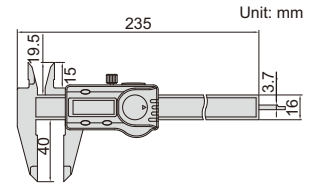

Code	Range	Accuracy
1139-150	0-150mm/0-6"	±0.1mm

DIAL CALIPERS

- Shockproof dial indicator
- Made of stainless steel

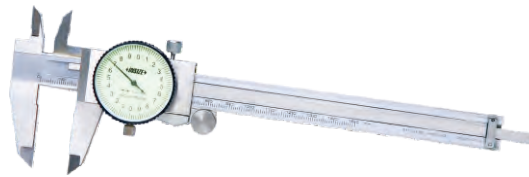

1312-150A

SHOCK PROOF

INSPECTION CERTIFICATE
TRACEABLE TO DKD

Dial indicator graduation: 0.02mm

(mm)

Code	Range	Accuracy	Thumb roller	L	a	b	c	d	D	t
1312-150A *	0-150mm	±0.03mm	with	235	21	16.5	16	40	Ø39	6.5
1312-200A *	0-200mm	±0.03mm	with	288	24	19	16	48	Ø39	6.5
1312-300A *	0-300mm	±0.03mm	with	410	28	22	20	62	Ø44.5	7.5
1312-100AW *	0-100mm	±0.02mm	without	165	18	13	13	30	Ø32	6

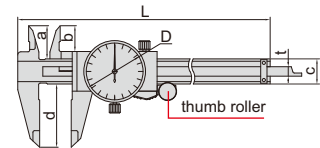

Dial indicator graduation: 0.01mm

(mm)

Code	Range	Accuracy	Thumb roller	L	a	b	c	d	D	t
1311-150A *	0-150mm	±0.03mm	with	235	21	16.5	16	40	Ø39	6.5
1311-200A *	0-200mm	±0.03mm	with	288	24	19	16	48	Ø39	6.5
1311-300A *	0-300mm	±0.03mm	with	410	28	22	20	62	Ø44.5	7.5

*Supplied with manufacturer inspection certificate traceable to DKD Germany

MINI VERNIER CALIPERS

- Meet DIN862
- Made of stainless steel
- Satin chrome plated reading surface

Code	Range	Graduation	Accuracy
1204-70	0-70mm	0.05mm	±0.05mm

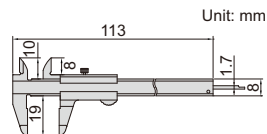

1204-70

Code	Range	Graduation	Accuracy
1203-1003	0-100mm	0.05mm	±0.05mm

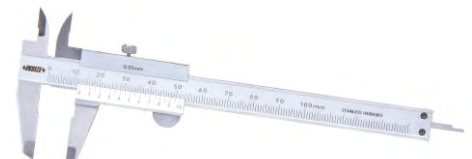
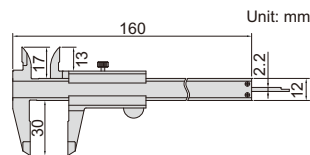

1203-1003

Code	Range	Graduation	Accuracy
1201-1003	0-100mm	0.05mm	±0.05mm

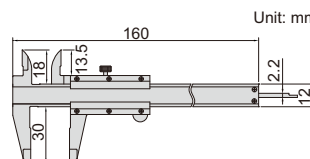

1201-1003

VERNIER CALIPERS

Graduation 0.05mm/1/128" (mm)

Code	Range	Accuracy	L	a	b	c	d
1205-150S	0-150mm/0-6"	±0.05mm	235	20.5	15.5	16	40
1205-200S	0-200mm/0-8"	±0.05mm	290	23.5	19	17	50
1205-250S	0-250mm/0-10"	±0.05mm	364	27.5	22	20	64
1205-300S	0-300mm/0-12"	±0.05mm	414	27.5	22	20	64



1205-150S

Graduation 0.05mm (mm)

Code	Range	Accuracy	L	a	b	c	d
1205-1503S	0-150mm	±0.05mm	235	20.5	15.5	16	40
1205-2003S	0-200mm	±0.05mm	290	23.5	19	17	50
1205-2503S	0-250mm	±0.05mm	350	26	21.5	16	60
1205-3003S	0-300mm	±0.05mm	414	27.5	22	20	64

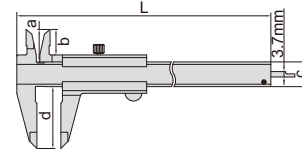

Graduation 0.02mm/0.001" (mm)

Code	Range	Accuracy	L	a	b	c	d
1205-1502S	0-150mm/0-6"	±0.03mm	235	20.5	15.5	16	40
1205-2002S	0-200mm/0-8"	±0.03mm	290	23.5	19	17	50
1205-2502S	0-250mm/0-10"	±0.03mm	364	27.5	22	20	64
1205-3002S	0-300mm/0-12"	±0.03mm	414	27.5	22	20	64

Graduation 0.02mm (mm)

Code	Range	Accuracy	L	a	b	c	d
1205-1501S	0-150mm	±0.03mm	235	20.5	15.5	16	40
1205-2001S	0-200mm	±0.03mm	290	23.5	19	17	50
1205-2501S	0-250mm	±0.03mm	350	26	21.5	16	60
1205-3001S	0-300mm	±0.03mm	414	27.5	22	20	64

- Meet DIN862
- Made of stainless steel
- Satin chrome plated reading surface

VERNIER CALIPER WITH ROUND DEPTH BAR

- Graduation 0.05mm/1/128"
- Round depth bar
- Meet DIN862
- Made of stainless steel
- Satin chrome plated reading surface



1202-150

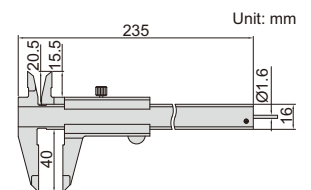

Code	Range	Accuracy
1202-150	0-150mm/0-6"	±0.05mm

VERNIER CALIPERS WITH FINE ADJUSTMENT

- Graduation 0.02mm/0.001"
- With fine adjustment
- Meet DIN862
- Made of stainless steel
- Satin chrome plated reading surface

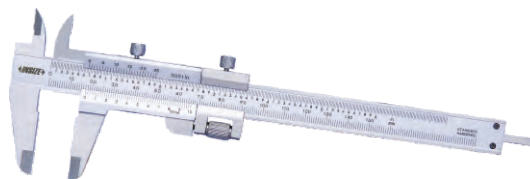

1233-130

Code	Range	Accuracy	L	a	b	c	d
1233-130	0-130mm/0-5"	±0.03mm	230	20.5	16.5	16	40
1233-180	0-180mm/0-7"	±0.03mm	295	23.5	19	16	50
1233-280	0-280mm/0-11"	±0.03mm	410	26	20	20	60

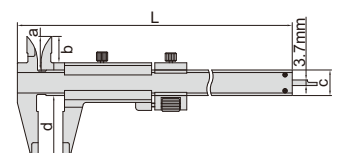

VERNIER CALIPERS WITH THUMB CLAMP

- Meet DIN862
- With thumb clamp
- Made of stainless steel
- Satin chrome plated reading surface

Graduation 0.05mm/1/128" (mm)

Code	Range	Accuracy	L	a	b	c	d
1223-150	0-150mm/0-6"	±0.05mm	230	20.5	16.5	16	40
1223-200	0-200mm/0-8"	±0.05mm	295	23.5	19	16	50

Graduation 0.02mm/0.001" (mm)

Code	Range	Accuracy	L	a	b	c	d
1223-1502	0-150mm/0-6"	±0.03mm	230	20.5	16.5	16	40
1223-2002	0-200mm/0-8"	±0.03mm	295	23.5	19	16	50



1223-150

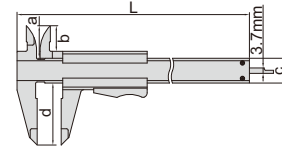

VERNIER CALIPERS WITH CARBIDE TIPPED JAWS

- Carbide tipped jaws for inside and outside measurements
- Meet DIN862
- Made of stainless steel
- Satin chrome plated reading surface

Graduation 0.05mm/1/128" (mm)

Code	Range	Accuracy	L	a	b	c	d
1238-150	0-150mm/0-6"	±0.05mm	230	21	16.5	16	40
1238-200	0-200mm/0-8"	±0.05mm	295	24	19	16	50
1238-300	0-300mm/0-12"	±0.05mm	410	25	20	17	60

Graduation 0.02mm/0.001" (mm)

Code	Range	Accuracy	L	a	b	c	d
1238-1502	0-150mm/0-6"	±0.03mm	230	21	16.5	16	40
1238-2002	0-200mm/0-8"	±0.03mm	295	24	19	16	50
1238-3002	0-300mm/0-12"	±0.03mm	410	25	20	17	60

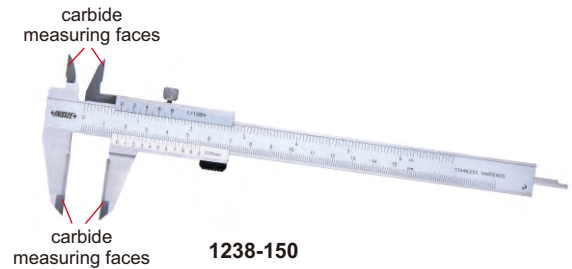

1238-150

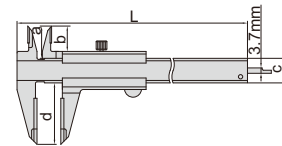

VERNIER CALIPERS

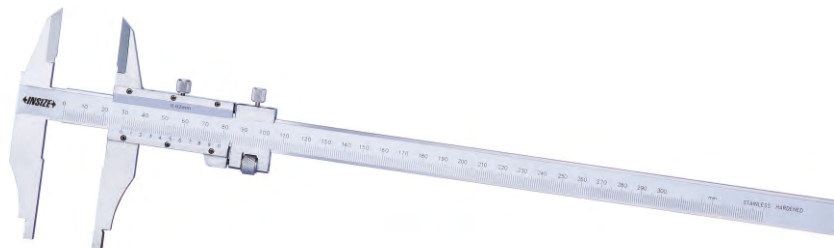

1217-3001

- With fine adjustment
- Made of stainless steel
- Satin chrome plated reading surface

Code	Range	Graduation	Accuracy	L
1217-2503	0-250mm	0.05mm	±0.05mm	360mm
1217-3001	0-300mm	0.02mm	±0.03mm	410mm

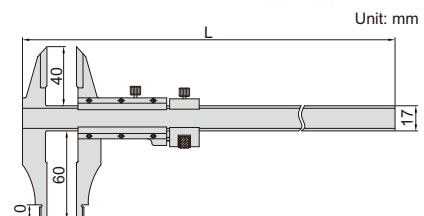
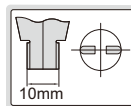

ATTENTION:
NOT HARDENED

PURE COPPER

VERNIER CALIPERS (ANTI MAGNETIC)

- Suitable for magnetic parts
- Made of pure copper



1224-150A

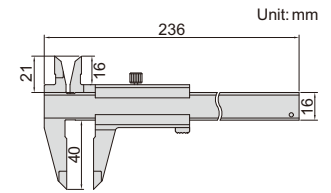

Code	Range	Graduation	Accuracy
1224-150A	0-150mm	0.02mm	±0.05mm
1224-1501A	0-150mm	0.05mm	±0.05mm

LEFT HAND VERNIER CALIPERS

- Designed for left handed users
- Made of stainless steel
- Satin chrome plated reading surface

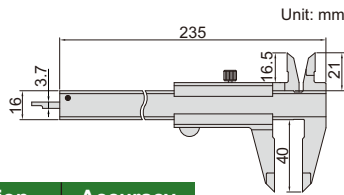

1239-1502

Code	Range	Graduation	Accuracy
1239-150	0-150mm/0-6"	0.05mm/1/128"	±0.05mm
1239-1503	0-150mm	0.05mm	±0.05mm
1239-1502	0-150mm/0-6"	0.02mm/0.001"	±0.03mm
1239-1501	0-150mm	0.02mm	±0.03mm

TEETH VERNIER CALIPER

- Used for teeth
- Made of stainless steel



1226-70

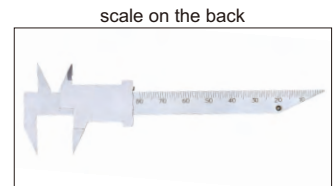
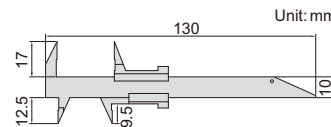

Code	Range	Graduation	Accuracy
1226-70	0-70mm	0.1mm	±0.1mm

DEPTH BASE ATTACHMENTS

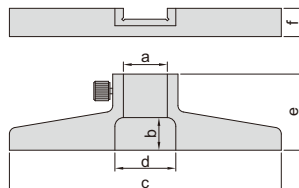

6140



6140-16B

- To increase the stability of depth measurement
- Suitable for digital calipers and dial calipers
- Made of stainless steel

(mm)

Code	a	b	c	d	e	f	Type	Application
6140	16.5	9	75	18	30	6	narrow base (f=6)	Suitable for calipers with beam width (w) 16mm
6140-300A	20	15	125	22	34	9	narrow base (f=9)	Suitable for calipers with beam width (w) 20mm
6140-16B	16	12.5	75	24.5	30	11	wide base (f=11), high stability	Suitable for calipers with beam width (w) 16mm
6140-300B	20	15	125	28	35	13	wide base (f=13), high stability	Suitable for calipers with beam width (w) 20mm

**ACCESSORY SET FOR DIGITAL CALIPERS
CODE 6144**



6144

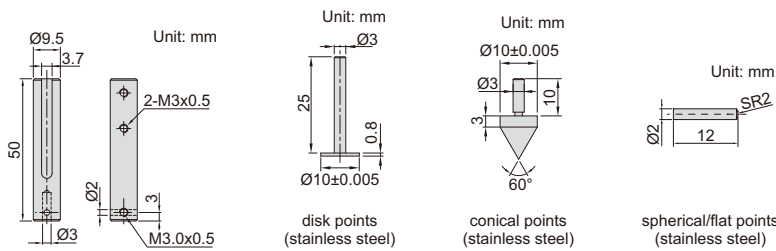

■ Suitable for 0-150mm/0-6" and 0-200mm/0-8" digital calipers (thickness of lower jaws ≤ 3.7mm)

Code
6144

**ACCESSORY SET FOR LARGE DIGITAL CALIPERS
CODE 6145-500**



6145-500

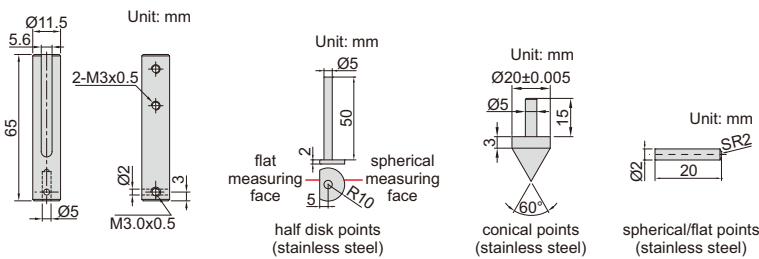

■ Suitable for 0-500mm/0-20" and 0-600mm/0-24" digital calipers (thickness of lower jaws ≤ 5.6mm)

Code
6145-500

ACCESSORY SET FOR LARGE DIGITAL CALIPERS (WITH SIDE POINTS) CODE 6146-500B



VIDEO



6146-500B

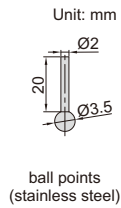
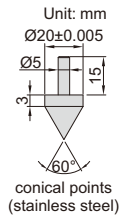
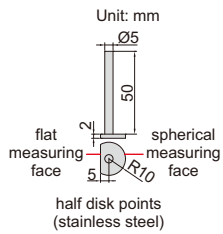
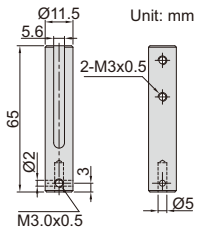

- Suitable for 0-500mm/0-20" and 0-600mm/0-24" digital calipers (thickness of lower jaws ≤ 5.6mm)

Code
6146-500B

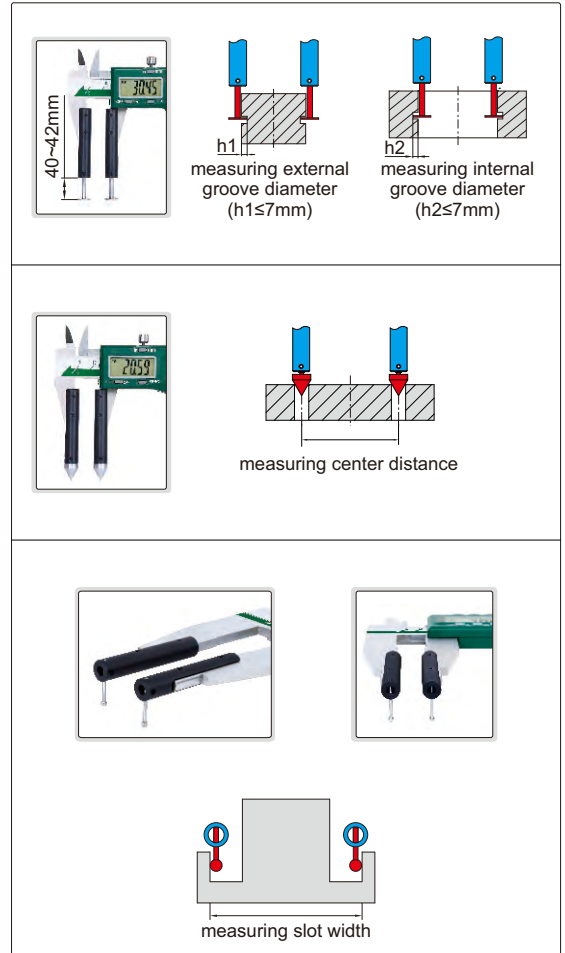

VIDEO

CALIPER END GRINDING MACHINE CODE 6309

- Used for grinding the depth measuring surface of the end of calipers

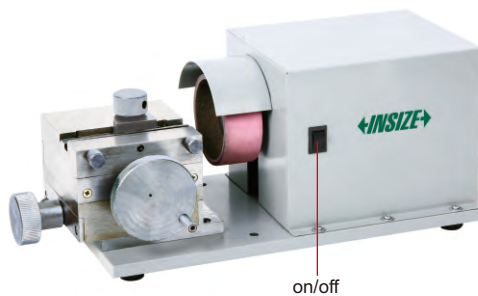

application



SPECIFICATION

Power supply	220V, 50/60Hz
Dimension (L×W×H)	370×200×160mm
Weight	15kg

IP65 WATERPROOF DIGITAL CALIPERS

IP65
WATERPROOF

DATA
OUTPUT

2

- IP65 dust/waterproof
- Resolution: 0.01mm/0.0005"
- Button function: on/off, zero, mm/inch, ABS, data preset
- Battery CR2032
- Automatic power off
- Made of stainless steel



1173-601

With data interface (data output cable code 7302-1104, wireless transmitter code 7315-1104, optional)

Code	Range	Accuracy
1173-601	0-600mm/0-24"	±0.05mm

Built in bluetooth

Code	Range	Accuracy
1173-601WL	0-600mm/0-24"	±0.05mm

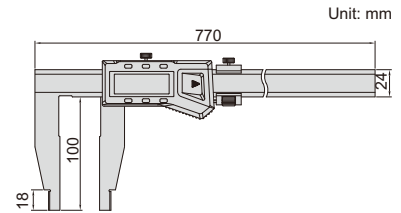
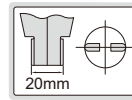

Unit: mm

DIGITAL CALIPERS

DATA
OUTPUT



1106-501

With data interface

(data output cable code 7315-22, 7302-22, optional, for calipers with c=24mm or 31mm)

Code	Range	Accuracy	a	c	d	e	L
1106-301	0-300mm/0-12"	±0.05mm	18mm	24mm	100mm	20mm	420mm
1106-302	0-300mm/0-12"	±0.05mm	18mm	24mm	150mm	20mm	420mm
1106-451	0-450mm/0-18"	±0.05mm	18mm	24mm	100mm	20mm	625mm
1106-501	0-500mm/0-20"	±0.05mm	18mm	24mm	100mm	20mm	675mm
1106-502	0-500mm/0-20"	±0.06mm	18mm	24mm	150mm	20mm	675mm
1106-503	0-500mm/0-20"	±0.06mm	24mm	31mm	200mm	20mm	675mm
1106-505	0-500mm/0-20"	±0.08mm	24mm	42mm	300mm	20mm	675mm
1106-601	0-600mm/0-24"	±0.05mm	18mm	24mm	100mm	20mm	770mm
1106-602	0-600mm/0-24"	±0.06mm	18mm	24mm	150mm	20mm	770mm
1106-603	0-600mm/0-24"	±0.06mm	24mm	31mm	200mm	20mm	770mm
1106-802	0-800mm/0-32"	±0.07mm	24mm	31mm	150mm	20mm	1025mm
1106-1002	0-1000mm/0-40"	±0.08mm	24mm	31mm	150mm	20mm	1220mm
1106-1003	0-1000mm/0-40"	±0.08mm	24mm	31mm	200mm	20mm	1220mm
1106-1005	0-1000mm/0-40"	±0.10mm	24mm	42mm	300mm	20mm	1220mm
1106-1502	0-1500mm/0-60"	±0.11mm	24mm	42mm	150mm	20mm	1780mm
1106-1503	0-1500mm/0-60"	±0.12mm	24mm	42mm	200mm	20mm	1780mm
1106-2002	0-2000mm/0-80"	±0.14mm	24mm	42mm	150mm	20mm	2290mm
1106-2003	0-2000mm/0-80"	±0.14mm	24mm	42mm	200mm	20mm	2290mm
1106-2502	0-2500mm/0-100"	±0.22mm	24mm	42mm	150mm	20mm	2800mm
1106-3002	0-3000mm/0-120"	±0.26mm	24mm	42mm	150mm	20mm	3300mm

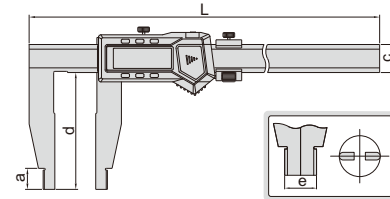

- Resolution: 0.01mm/0.0005"
- Button function: on/off, zero, mm/inch, ABS, data preset
- Battery CR2032
- Made of stainless steel

Built-in wireless (receiver code 7315-2/3/6/7/8 is required)

Code	Range	Accuracy	a	c	d	e	L
1106-301WL	0-300mm/0-12"	±0.05mm	18mm	24mm	100mm	20mm	420mm
1106-302WL	0-300mm/0-12"	±0.05mm	18mm	24mm	150mm	20mm	420mm
1106-451WL	0-450mm/0-18"	±0.05mm	18mm	24mm	100mm	20mm	625mm
1106-501WL	0-500mm/0-20"	±0.05mm	18mm	24mm	100mm	20mm	675mm
1106-502WL	0-500mm/0-20"	±0.06mm	18mm	24mm	150mm	20mm	675mm
1106-601WL	0-600mm/0-24"	±0.05mm	18mm	24mm	100mm	20mm	770mm
1106-602WL	0-600mm/0-24"	±0.06mm	18mm	24mm	150mm	20mm	770mm

DATA
OUTPUT

DIGITAL CALIPERS

2

- Resolution: 0.01mm/0.0005"
- Button function: on/off, zero, mm/inch, ABS, data preset
- Battery CR2032
- Made of stainless steel



1117-501

With data interface (data output cable code 7315-22, 7302-22, optional)

Code	Range	Accuracy	a	b	c	d	e	L
1117-301	0-300mm/0-12"	±0.05mm	18mm	56mm	24mm	100mm	20mm	420mm
1117-501	0-500mm/0-20"	±0.05mm	18mm	56mm	24mm	100mm	20mm	675mm
1117-502	0-500mm/0-20"	±0.06mm	18mm	56mm	24mm	150mm	20mm	675mm
1117-601	0-600mm/0-24"	±0.05mm	18mm	56mm	24mm	100mm	20mm	770mm
1117-802	0-800mm/0-32"	±0.07mm	24mm	67mm	31mm	150mm	20mm	1025mm
1117-1002	0-1000mm/0-40"	±0.08mm	24mm	67mm	31mm	150mm	20mm	1220mm

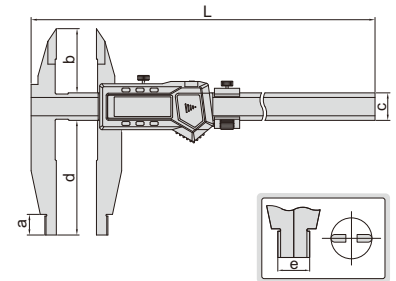

Built-in wireless (receiver code 7315-2/3/6/7/8 is required)

Code	Range	Accuracy	a	b	c	d	e	L
1117-301WL	0-300mm/0-12"	±0.05mm	18mm	56mm	24mm	100mm	20mm	420mm
1117-501WL	0-500mm/0-20"	±0.05mm	18mm	56mm	24mm	100mm	20mm	675mm
1117-502WL	0-500mm/0-20"	±0.06mm	18mm	56mm	24mm	150mm	20mm	675mm
1117-601WL	0-600mm/0-24"	±0.05mm	18mm	56mm	24mm	100mm	20mm	770mm

DATA
OUTPUT

DIGITAL CALIPERS

- Resolution: 0.01mm/0.0005"
- Button function: on/off, zero, mm/inch, ABS, data preset
- Battery CR2032
- Made of stainless steel

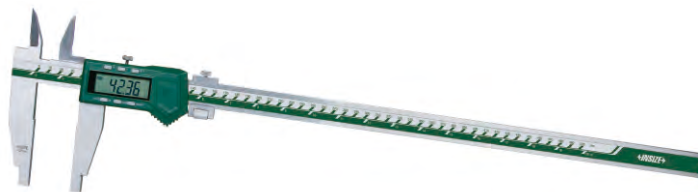

1136-501

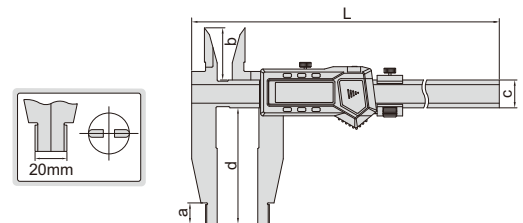

With data interface (data output cable code 7315-22, 7302-22, optional, for calipers with c=24mm or 31mm) (mm)

Code	Range	Accuracy	a	b	c	d	L
1136-301	0-300mm/0-12"	±0.05mm	18	45	24	100	420
1136-451	0-450mm/0-18"	±0.05mm	18	45	24	100	625
1136-501	0-500mm/0-20"	±0.05mm	18	45	24	100	675
1136-502	0-500mm/0-20"	±0.06mm	18	45	24	150	675
1136-503	0-500mm/0-20"	±0.06mm	24	60	31	200	675
1136-601	0-600mm/0-24"	±0.05mm	18	45	24	100	770
1136-1002	0-1000mm/0-40"	±0.08mm	24	60	31	150	1220
1136-1502	0-1500mm/0-60"	±0.11mm	24	60	42	150	1780
1136-2002	0-2000mm/0-80"	±0.14mm	24	60	42	150	2290

Built-in wireless (receiver code 7315-2/3/6/7/8 is required) (mm)

Code	Range	Accuracy	a	b	c	d	L
1136-301WL	0-300mm/0-12"	±0.05mm	18	45	24	100	420
1136-451WL	0-450mm/0-18"	±0.05mm	18	45	24	100	625
1136-501WL	0-500mm/0-20"	±0.05mm	18	45	24	100	675
1136-502WL	0-500mm/0-20"	±0.06mm	18	45	24	150	675
1136-601WL	0-600mm/0-24"	±0.05mm	18	45	24	100	770

DIGITAL CALIPERS

DATA OUTPUT

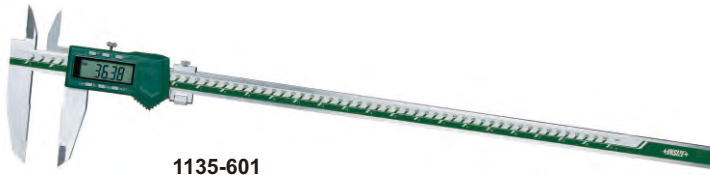

1135-601

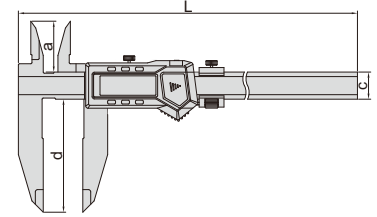

- Resolution: 0.01mm/0.0005"
- Button function: on/off, zero, mm/inch, ABS, data preset
- Battery CR2032
- Made of stainless steel

With data interface (data output cable code 7315-22, 7302-22, optional)

Code	Range	Accuracy	a	c	d	L
1135-451	0-450mm/0-18"	±0.05mm	45	24	100	625
1135-601	0-600mm/0-24"	±0.05mm	45	24	100	770
1135-1002	0-1000mm/0-40"	±0.08mm	60	31	150	1220

Built-in wireless (receiver code 7315-2/3/6/7/8 is required)

Code	Range	Accuracy	a	c	d	L
1135-451WL	0-450mm/0-18"	±0.05mm	45	24	100	625
1135-601WL	0-600mm/0-24"	±0.05mm	45	24	100	770

VERNIER CALIPERS (SOLID TYPE)

- With fine adjustment
- Made of stainless steel
- Satin chrome plated reading surface

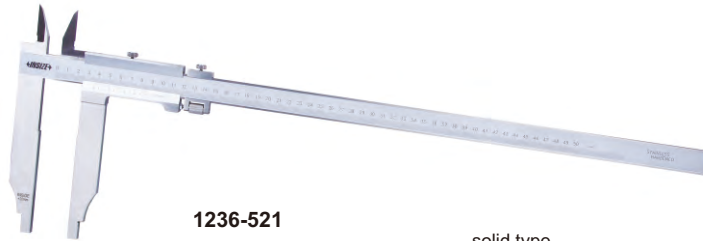

1236-521

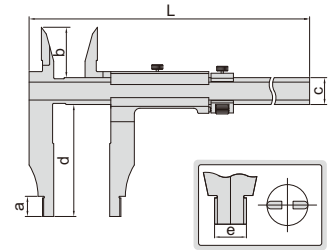

solid type (without screw)



Graduation 0.05mm/1/128"

Code	Range	Accuracy	a	b	c	d	e	L
1236-394	0-300mm/0-12"	±0.07mm	12	38	20	90	10	450
1236-514	0-500mm/0-20"	±0.07mm	18	45	24	100	20	670
1236-524	0-500mm/0-20"	±0.08mm	18	45	24	150	20	670
1236-614	0-600mm/0-24"	±0.08mm	18	45	24	100	20	770
1236-824	0-800mm/0-32"	±0.09mm	24	60	31	150	20	1030
1236-1024	0-1000mm/0-40"	±0.12mm	24	60	31	150	20	1230

Graduation 0.02mm

Code	Range	Accuracy	a	b	c	d	e	L
1236-511	0-500mm	±0.05mm	18	45	24	100	20	670
1236-521	0-500mm	±0.06mm	18	45	24	150	20	670
1236-1021	0-1000mm	±0.08mm	24	60	31	150	20	1230

VERNIER CALIPERS (SOLID TYPE)

- Graduation 0.05mm/1/128"
- With fine adjustment
- Made of stainless steel
- Satin chrome plated reading surface



1207-514

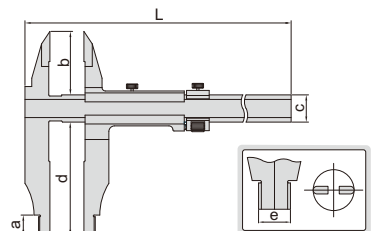

solid type (without screw)



Code	Range	Accuracy	a	b	c	d	e	L
1207-394	0-300mm/0-12"	±0.07mm	12	40	20	90	10	440
1207-514	0-500mm/0-20"	±0.07mm	18	56	24	100	20	670
1207-524	0-500mm/0-20"	±0.08mm	18	56	24	150	20	670
1207-824	0-800mm/0-32"	±0.09mm	24	67	31	150	20	930
1207-1024	0-1000mm/0-40"	±0.12mm	24	67	31	150	20	1230

VERNIER CALIPERS (SOLID TYPE)

- With fine adjustment
- Made of stainless steel
- Satin chrome plated reading surface



1208-511

Graduation 0.05mm/1/128" (mm)

Code	Range	Accuracy	a	c	d	e	L
1208-214	0-200mm/0-8"	±0.06mm	10	20	100	10	330
1208-394	0-300mm/0-12"	±0.07mm	10	20	90	10	410
1208-324	0-300mm/0-12"	±0.07mm	18	24	150	20	410
1208-524	0-500mm/0-20"	±0.08mm	18	24	150	20	670
1208-614	0-600mm/0-24"	±0.08mm	18	24	100	20	770
1208-624	0-600mm/0-24"	±0.09mm	18	24	150	20	770
1208-824	0-800mm/0-32"	±0.09mm	24	31	150	20	1030
1208-1024	0-1000mm/0-40"	±0.12mm	24	31	150	20	1230
1208-1524	0-1500mm/0-60"	±0.16mm	24	42	150	20	1820
1208-2024	0-2000mm/0-80"	±0.20mm	24	42	150	20	2330

solid type
(without screw)



Graduation 0.02mm (mm)

Code	Range	Accuracy	a	c	d	e	L
1208-511	0-500mm	±0.05mm	18	24	100	20	670
1208-521	0-500mm	±0.06mm	18	24	150	20	670
1208-1021	0-1000mm	±0.08mm	24	31	150	20	1230
1208-1521	0-1500mm	±0.11mm	24	42	150	20	1820

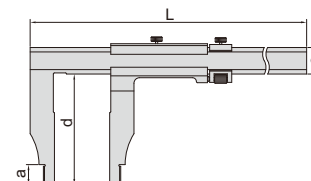
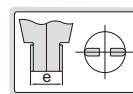

VERNIER CALIPERS (SOLID TYPE)

- With fine adjustment
- Made of stainless steel
- Satin chrome plated reading surface



1210-611

Graduation 0.05mm/1/128" (mm)

Code	Range	Accuracy	a	c	d	L
1210-614	0-600mm/0-24"	±0.08mm	45	24	100	770
1210-1024	0-1000mm/0-40"	±0.12mm	60	31	150	1230

Graduation 0.02mm (mm)

Code	Range	Accuracy	a	c	d	L
1210-611	0-600mm	±0.05mm	45	24	100	770
1210-1021	0-1000mm	±0.08mm	60	31	150	1230

solid type
(without screw)

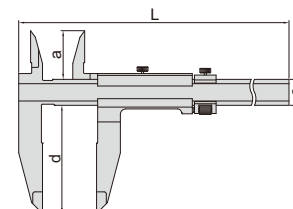

VERNIER CALIPERS (SEPARATE TYPE)

- With fine adjustment
- Made of stainless steel
- Satin chrome plated reading surface



1214-500

Graduation 0.02mm/0.001" (mm)

Code	Range	Accuracy	a	c	d	e	L
1214-300	0-300mm/0-12"	±0.05mm	10	20	75	10	410
1214-450	0-450mm/0-18"	±0.05mm	18	24	100	20	620
1214-500	0-500mm/0-20"	±0.05mm	18	24	100	20	670
1214-600	0-600mm/0-24"	±0.05mm	18	24	100	20	770
1214-1000	0-1000mm/0-40"	±0.08mm	24	32	140	20	1216
1214-1500	0-1500mm/0-60"	±0.12mm	24	42	200	20	1830
1214-2000	0-2000mm/0-80"	±0.14mm	24	42	200	20	2320

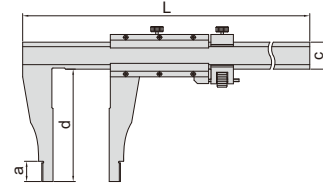

separate type
(with screws)

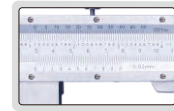
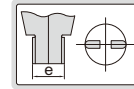

Graduation 0.05mm/1/128" (mm)

Code	Range	Accuracy	a	c	d	e	L
1214-6004	0-600mm/0-24"	±0.08mm	18	24	100	20	770
1214-1004	0-1000mm/0-40"	±0.12mm	24	32	140	20	1216

LONG JAW VERNIER CALIPERS (SEPARATE TYPE)

- With fine adjustment
- Made of stainless steel
- Satin chrome plated reading surface



1215-1032

Graduation 0.02mm/0.001" (mm)

Code	Range	Accuracy	a	c	d	e	L
1215-392	0-300mm/0-12"	±0.05mm	10	17	90	10	410
1215-322	0-300mm/0-12"	±0.05mm	18	24	150	20	470
1215-522	0-500mm/0-20"	±0.06mm	18	24	150	20	670
1215-532	0-500mm/0-20"	±0.06mm	18	24	200	20	670
1215-622	0-600mm/0-24"	±0.06mm	18	24	150	20	770
1215-642	0-600mm/0-24"	±0.08mm	24	32	250	20	870
1215-822	0-800mm/0-32"	±0.07mm	24	32	150	20	1020
1215-832	0-800mm/0-32"	±0.07mm	24	32	200	20	1020
1215-1032	0-1000mm/0-40"	±0.08mm	24	32	200	20	1220
1215-1052	0-1000mm/0-40"	±0.11mm	24	42	300	20	1330
1215-3052	0-3000mm/0-120"	±0.26mm	24	50	300	20	3360

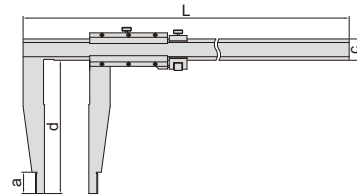

separate type
(with screws)

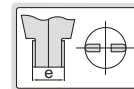

Graduation 0.05mm/1/128" (mm)

Code	Range	Accuracy	a	c	d	e	L
1215-524	0-500mm/0-20"	±0.08mm	18	24	150	20	670
1215-1034	0-1000mm/0-40"	±0.12mm	24	32	200	20	1330

CARBON FIBER RODS, LIGHT WEIGHT, NOT EASY TO DEFORM, NO TEMPERATURE EXPAND, SUITABLE FOR THIN-WALL WORKPIECES AND LARGE-SIZE WORKPIECES

CARBON FIBER COMPARISON GAGES

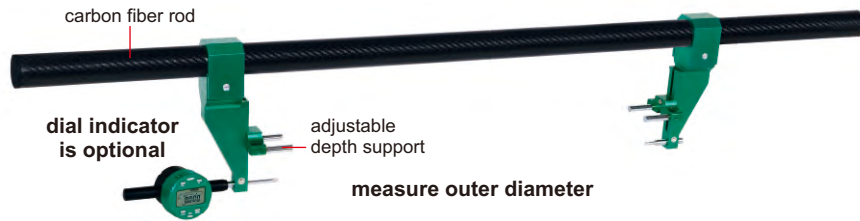

2931-D1000A

- Measure outer diameter, inside diameter, holes distance and cylindrical workpiece length
- Carbon fiber rods, light weight, not easy to deform, no temperature expand
- Optional accessory: cylinder gage blocks (code 4001)

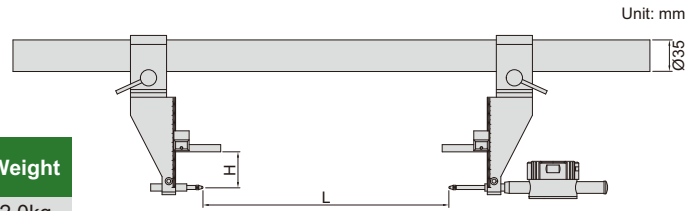

Code	Maximum measuring range (L)	Measuring depth (H)	Repeatability	Weight
2931-D1000A	1000mm	0-100mm	5μm	2.0kg
2931-D1000B	1000mm	0-200mm	10μm	2.3kg
2931-D1000C	1000mm	0-300mm	15μm	2.6kg
2931-D1500A	1500mm	0-100mm	6μm	2.3kg
2931-D1500B	1500mm	0-200mm	15μm	2.6kg
2931-D1500C	1500mm	0-300mm	25μm	2.9kg
2931-D2000A	2000mm	0-100mm	8μm	2.6kg
2931-D2000B	2000mm	0-200mm	20μm	2.9kg
2931-D2000C	2000mm	0-300mm	35μm	3.2kg
2931-D2500A	2500mm	0-100mm	10μm	2.9kg
2931-D2500B	2500mm	0-200mm	25μm	3.2kg
2931-D2500C	2500mm	0-300mm	45μm	3.5kg
2931-D3000A	3000mm	0-100mm	13μm	3.2kg
2931-D3000B	3000mm	0-200mm	30μm	3.5kg
2931-D3000C	3000mm	0-300mm	60μm	3.8kg
2931-D4000A	4000mm	0-100mm	18μm	3.8kg
2931-D4000B	4000mm	0-200mm	35μm	4.1kg
2931-D4000C	4000mm	0-300mm	70μm	4.4kg
2931-D5000A	5000mm	0-100mm	25μm	4.4kg
2931-D5000B	5000mm	0-200mm	40μm	4.7kg
2931-D5000C	5000mm	0-300mm	80μm	5.0kg
2931-D6000A	6000mm	0-100mm	30μm	5.0kg
2931-D6000B	6000mm	0-200mm	45μm	5.3kg
2931-D6000C	6000mm	0-300mm	95μm	5.6kg
2931-D7000A	7000mm	0-100mm	80μm	5.6kg
2931-D7000B	7000mm	0-200mm	90μm	5.9kg
2931-D7000C	7000mm	0-300mm	110μm	6.2kg
2931-D8000A	8000mm	0-100mm	100μm	6.2kg
2931-D8000B	8000mm	0-200mm	120μm	6.5kg
2931-D8000C	8000mm	0-300mm	130μm	6.8kg
2931-D9000A	9000mm	0-100mm	120μm	6.8kg
2931-D9000B	9000mm	0-200mm	130μm	7.1kg
2931-D9000C	9000mm	0-300mm	150μm	7.4kg

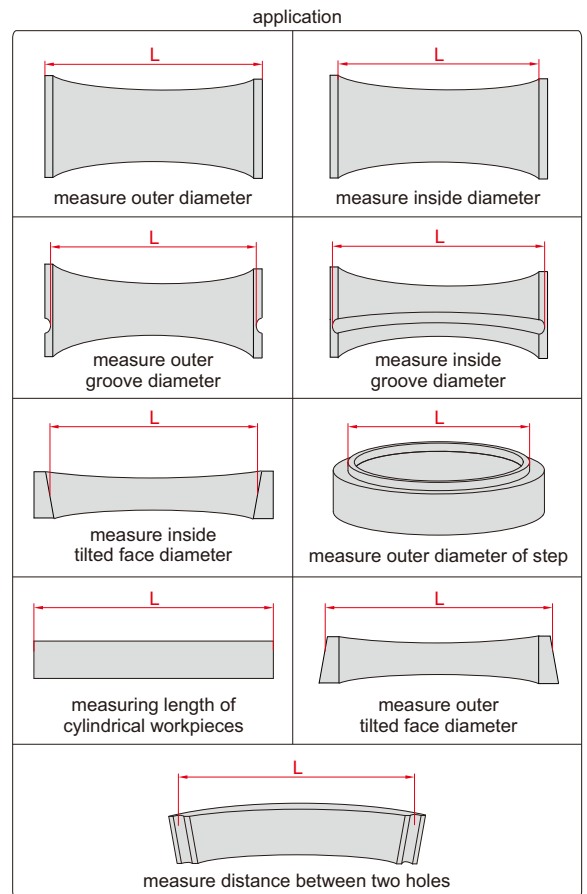

UNIVERSAL CALIPERS

DATA OUTPUT

2

working with stands

working with measuring jaws



1125-600

- Buttons: on/off, set, mm/inch, ABS, preset (+, -)
- Automatic power off, move the digital unit to turn on power
- Battery CR2032
- Made of stainless steel

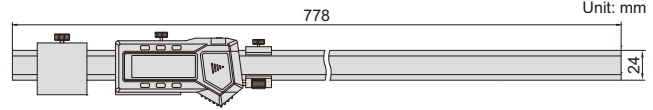

With data interface (data output cable code 7315-22, 7302-22, optional)

Code	Range *	Resolution	Accuracy
1125-600	0-600mm/0-24"	0.01mm/0.0005"	±0.05mm

*The range changes according to different points

Built-in wireless (receiver code 7315-2/3/6/7/8 is required)

Code	Range *	Resolution	Accuracy
1125-600WL	0-600mm/0-24"	0.01mm/0.0005"	±0.05mm

*The range changes according to different points

Half disk points (included)

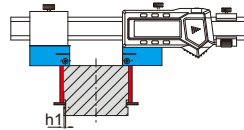
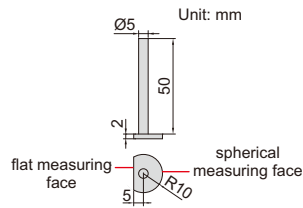

Measuring external groove diameter with flat measuring face (depth $h1 \leq 2.5\text{mm}$)

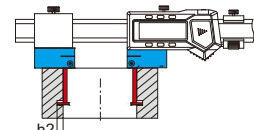

Measuring internal groove diameter with spherical measuring face (depth $h2 \leq 7.5\text{mm}$)

Conical points (optional)

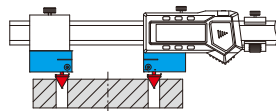
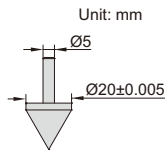

Measuring center distance

Code
1125-T101

Round shoulder points (optional)

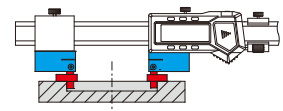
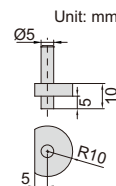

Measure inside diameter of shallow hole

Code
1125-T102

Flat shoulder points (optional)

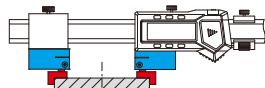
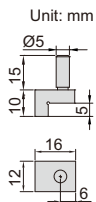

Measure outside diameter of low boss

Code
1125-T103

Spherical points (included)

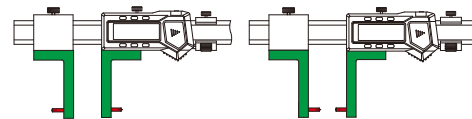
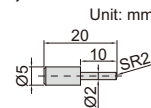

Point sleeve (optional)

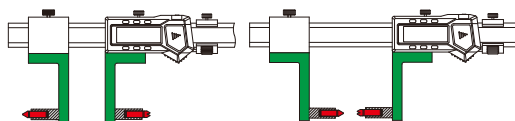
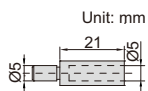

Working with multifunctional points, ball points and screw thread points

Code
1125-T104

Stands (included)

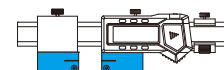
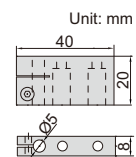

To be continued

Continued from previous page

Depth stop (included)

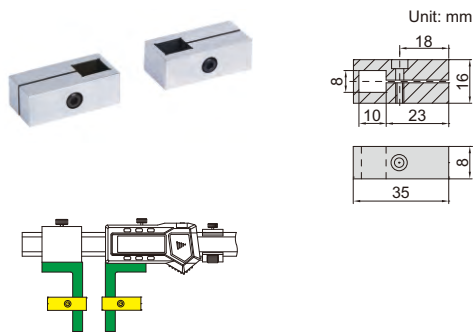

Measuring jaws (included)

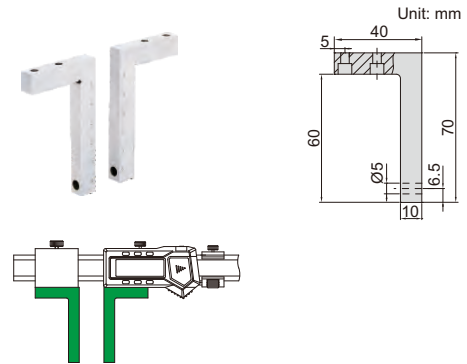

Multifunctional points 7392* (optional, page 31)



Ball points 7391* (optional, page 31)



Screw thread points 7381*, 7321* (optional, page 31)



* It is necessary to use point sleeve (code 1125-T104) for these points

DATA OUTPUT



DIGITAL CALIPERS WITH INTERCHANGEABLE POINTS

preset buttons

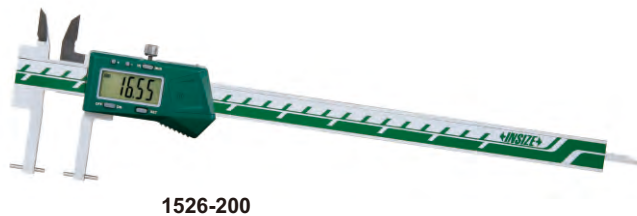

1526-200

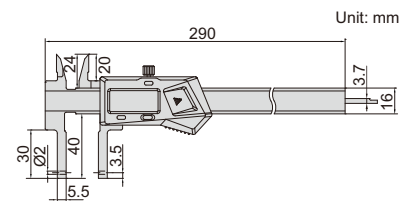

- Supplied with 3 pairs of points and zero setting block for external measurement
- Resolution: 0.01mm/0.0005"
- Buttons: on/off, set, mm/inch, preset (+, -)
- Automatic power off, move the digital unit to turn on power
- Battery CR2032
- Made of stainless steel
- Optional accessory: points

short spherical points (included) Unit: mm



long spherical/flat points (included) Unit: mm



spherical blade points (included) Unit: mm



With data interface

Code	Data output cable (optional)
1526-200	code 7315-21, 7302-21

Built-in wireless

Code	Receiver (optional)
1526-200WL	code 7315-2/3/6/7/8

Point	Range	Accuracy	Application
short spherical points	12-212mm/0.5-8.5" (internal)	±0.03mm	for grooves inside small hole
long spherical/flat points	24-224mm/1-8.8" (internal) 0-187mm/0-7.5" (external)	±0.03mm	spherical points for grooves inside hole flat points for external grooves
spherical blade points	24-224mm/1-8.8" (internal) 0-187mm/0-7.5" (external)	±0.03mm	for narrow grooves inside hole

To be continued

Continued from previous page

2

zero setting block for external measurement (included)



install points

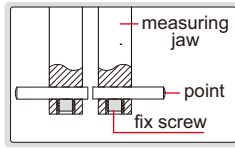

measure internal and external grooves

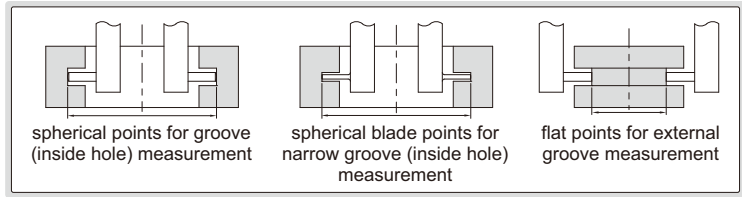

Depth stop (optional)

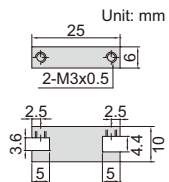

6143



Code

6143

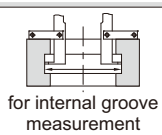
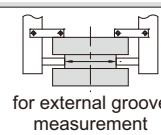

Point sleeve (optional)



1526-T101

Code

1526-T101

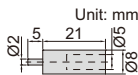

installation

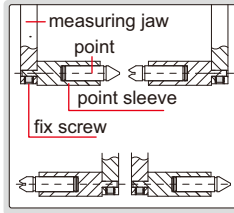

Ball points (optional)



7391-T5

Unit: mm



Code

Ball dia. (D)

7391-T3 *	SØ2.0mm
7391-T4 *	SØ2.5mm
7391-T5 *	SØ3.0mm
7391-T6 *	SØ3.5mm
7391-T7 *	SØ4.0mm
7391-T8 *	SØ4.5mm
7391-T9 *	SØ5.0mm
7391-T10 *	SØ6.0mm

* It is necessary to use point sleeve (code 1526-T101) for these points

Multifunctional points (optional)



7392-T1



7392-T2



7392-T3



7392-T4



7392-T5



7392-T6



7392-T7



7392-T8



7392-T9

Code	Type
7392-T1 *	flat
7392-T2 *	spherical
7392-T3 *	spline

Code	Type
7392-T4 *	disk
7392-T5 *	blade
7392-T6 *	knife-edge

Code	Type
7392-T7 *	point
7392-T8 *	knife-edge
7392-T9 *	point

* It is necessary to use point sleeve (code 1526-T101) for these points

Screw thread points (optional)



7321-T16

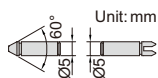

Internal thread (60° thread angle)

Code	Pitch
7321-T11 *	0.4-0.5mm/64-48TPI
7321-T12 *	0.6-0.9mm/44-28TPI
7321-T13 *	1-1.75mm/24-14TPI
7321-T14 *	2-3mm/13-9TPI
7321-T15 *	3.5-5mm/8-5TPI
7321-T16 *	5.5-7mm/4.5-3.5TPI
7321-T1S *	6 pairs/set, including all above points



7381-T11

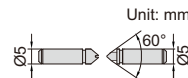

External thread (60° thread angle)

Code	Pitch
7381-T11 *	0.4-0.5mm/64-48TPI
7381-T12 *	0.6-0.9mm/44-28TPI
7381-T13 *	1-1.75mm/24-14TPI
7381-T14 *	2-3mm/13-9TPI
7381-T15 *	3.5-5mm/8-5TPI
7381-T16 *	5.5-7mm/4.5-3.5TPI
7381-TS *	6 pairs/set, including all above points

* It is necessary to use point sleeve (code 1526-T101) for these points

DATA
OUTPUT

DIGITAL CALIPERS WITH INTERCHANGEABLE POINTS



short spherical/flat points (included)

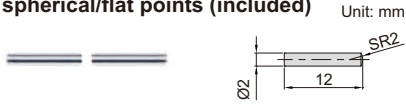

Unit: mm



1124-300A

long spherical/flat points (included)



Unit: mm

short spherical blade points (included)

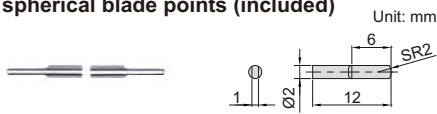

Unit: mm

long spherical blade points (included)

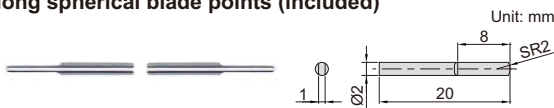

Unit: mm

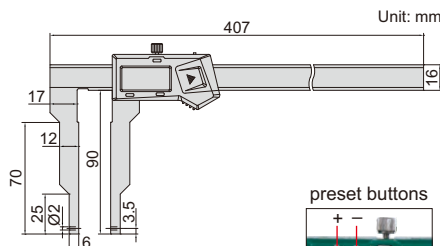

Unit: mm

zero setting block for external measurement (included)



measure internal and external grooves

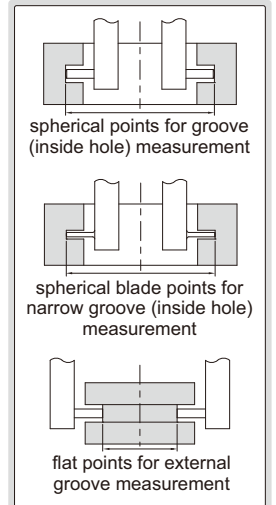

- Supplied with 4 pairs of points and zero setting block for external measurement
- Resolution: 0.01mm/0.0005"
- Buttons: on/off, set, mm/inch, preset (+, -)
- Automatic power off, move the digital unit to turn on power
- Battery CR2032
- Made of stainless steel
- Optional accessory: points (code 1526-T101, 7392, 7391, 7381, 7321), depth stop (code 6143)

preset buttons

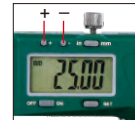

install points

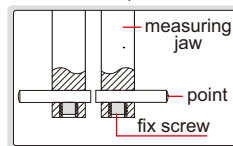

depth stop 6143 (optional)



With data interface

Code	Data output cable (optional)
1124-300A	code 7315-21, 7302-21

Built-in wireless

Code	Receiver (optional)
1124-300AWL	code 7315-2/3/6/7/8

Point	Range	Accuracy	Application
short spherical/flat points	24-324mm/1-12.7" (internal) 0-288mm/0-11.3" (external)	±0.04mm	spherical points for grooves inside hole (small hole) flat points for external grooves
long spherical/flat points	40-340mm/1.5-13.3" (internal) 0-272mm/0-10.7" (external)	±0.04mm	spherical points for grooves inside hole (large hole) flat points for external grooves
short spherical blade points	24-324mm/1-12.7" (internal) 0-288mm/0-11.3" (external)	±0.04mm	for narrow grooves inside hole (small hole)
long spherical blade points	40-340mm/1.5-13.3" (internal) 0-272mm/0-10.7" (external)	±0.04mm	for narrow grooves inside hole (large hole)

Multifunctional points 7392* (optional, page 31)

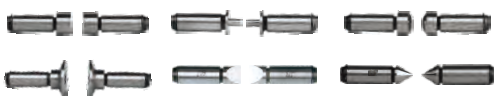

Ball points 7391* (optional, page 31)



Screw thread points 7381*, 7321* (optional, page 31)



* It is necessary to use point sleeve (code 1526-T101) for these points

DIGITAL CALIPERS WITH INTERCHANGEABLE POINTS



DATA OUTPUT

VARIOUS POINTS ARE AVAILABLE (PAGE 164~166)

- Supplied with 4 pairs of points and zero setting block for external measurement
- Resolution: 0.01mm/0.0005"
- Buttons: on/off, set, mm/inch, preset (+, -)
- Automatic power off, move the digital unit to turn on power
- Battery CR2032
- Made of stainless steel
- Optional accessory: points (page 164~166), depth stop (code 6143)

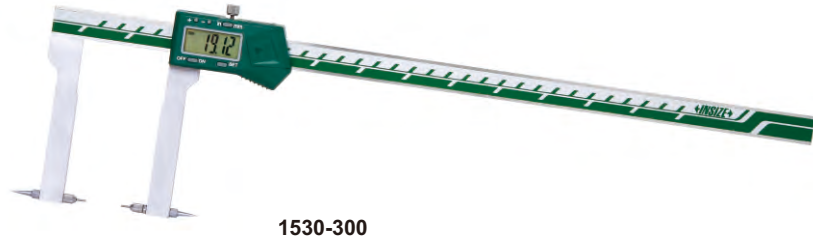

1530-300

zero setting block for external measurement (included)

depth stop 6143 (optional)

preset buttons

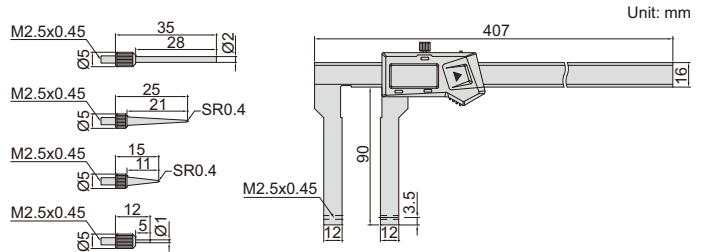

With data interface (data output cable code 7315-21, 7302-21, optional)

Code	Range*	Accuracy
1530-300	0-300mm/0-12"	±0.04mm

Built-in wireless (receiver code 7315-2/3/6/7/8 is required)

Code	Range*	Accuracy
1530-300WL	0-300mm/0-12"	±0.04mm

4 pairs of points (included)

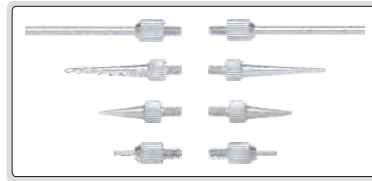

measure internal and external grooves

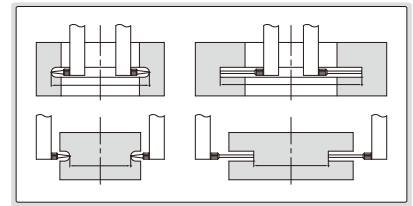

*For different points, the measuring range changes accordingly

DIGITAL INSIDE GROOVE CALIPERS

preset buttons



1520-150



1520-150P

depth stop 6143 (optional)

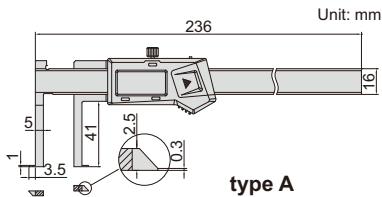

type A

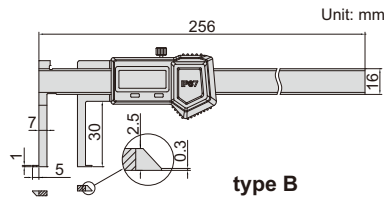
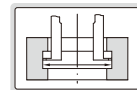

type B

- Measure diameter of grooves inside small bores
- Resolution: 0.01mm/0.0005"
- Buttons type A: on/off, set, mm/inch, preset (+, -), type B: on/off, zero, mm/inch, ABS/REL, hold
- Battery CR2032
- Made of stainless steel
- Optional accessory: depth stop (code 6143)

No dust/waterproof, built-in wireless (receiver code 7315-2/3/6/7/8 is required)

Code	Range	Type	Accuracy
1520-150WL	11-150mm/0.43-6"	A	±0.04mm

No dust/waterproof, with data interface (data output cable code 7315-21, 7302-21, optional)

Code	Range	Type	Accuracy
1520-150	11-150mm/0.43-6"	A	±0.04mm

IP67 dust/waterproof, no automatic power off, set zero after power on each time, without data interface

Code	Range	Type	Accuracy
1520-150P	14-150mm/0.56-6"	B	±0.04mm

DIGITAL INSIDE GROOVE CALIPERS

depth stop **6143**
(optional)



- Measure groove diameter
- Resolution: 0.01mm/0.0005"
- Buttons type A: on/off, set, mm/inch, preset (+, -)
type B: on/off, zero, mm/inch
type C: on/off, zero, mm/inch, ABS/REL, hold
- Battery CR2032
- Made of stainless steel
- Optional accessory: depth stop
(code **6143**, for calipers with c=16mm)

preset buttons



1120-150A
type A



1120-150B
type B



1120-150P
type C

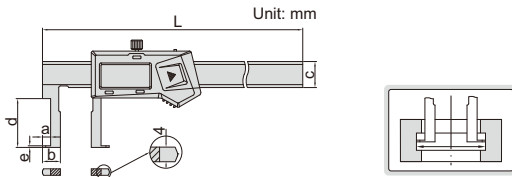

No dust/waterproof, preset (no need to add the width of the jaws on the reading), with data interface

(mm)

Code	Range	Type	Accuracy	L	a	b	c	d	e	Data output cable (optional)
1120-150A	22-150mm/0.87-6"	A	±0.04mm	250	5	11	16	30	1	7315-21, 7302-21
1120-1501	35-150mm/1.38-6"	A	±0.06mm	250	6	17.5	16	60	1.5	7315-21, 7302-21
1120-200A	25-200mm/0.98-8"	A	±0.04mm	310	5	12.5	16	40	1	7315-21, 7302-21
1120-2001	40-200mm/1.57-8"	A	±0.06mm	310	7	20	16	70	2.5	7315-21, 7302-21
1120-300A	30-300mm/1.18-12"	A	±0.05mm	410	5	15	16	50	1.5	7315-21, 7302-21
1120-3001	50-300mm/1.97-12"	A	±0.07mm	410	8	25	16	80	2.5	7315-21, 7302-21
1120-500	40-500mm/1.57-20"	A	±0.07mm	680	5	20	24	90	2.2	7315-22, 7302-22
1120-5001	60-500mm/2.36-20"	A	±0.08mm	680	10	30	24	120	3.4	7315-22, 7302-22
1120-5002	80-500mm/3.15-20"	A	±0.08mm	680	16	40	24	150	5.2	7315-22, 7302-22

No dust/waterproof, preset (no need to add the width of the jaws on the reading),
built-in wireless (receiver code 7315-2/3/6/7/8 is required)

Code	Range	Type	Accuracy	L	a	b	c	d	e
1120-150AWL	22-150mm/0.87-6"	A	±0.04mm	250mm	5mm	11mm	16mm	30mm	1mm
1120-1501WL	35-150mm/1.38-6"	A	±0.06mm	250mm	6mm	17.5mm	16mm	60mm	1.5mm
1120-200AWL	25-200mm/0.98-8"	A	±0.04mm	310mm	5mm	12.5mm	16mm	40mm	1mm
1120-2001WL	40-200mm/1.57-8"	A	±0.06mm	310mm	7mm	20mm	16mm	70mm	2.5mm
1120-300AWL	30-300mm/1.18-12"	A	±0.05mm	410mm	5mm	15mm	16mm	50mm	1.5mm
1120-3001WL	50-300mm/1.97-12"	A	±0.07mm	410mm	8mm	25mm	16mm	80mm	2.5mm
1120-500WL	40-500mm/1.57-20"	A	±0.07mm	680mm	5mm	20mm	24mm	90mm	2.2mm
1120-5001WL	60-500mm/2.36-20"	A	±0.08mm	680mm	10mm	30mm	24mm	120mm	3.4mm
1120-5002WL	80-500mm/3.15-20"	A	±0.08mm	680mm	16mm	40mm	24mm	150mm	5.2mm

No dust/waterproof, no preset (need to add the width of the jaws on the reading)

Code	Range	Type	Accuracy	L	a	b	c	d	e
1120-150B	50-150mm/1.97-6"	B	±0.06mm	270mm	8mm	25mm	20mm	90mm	3.4mm
1120-200B	60-200mm/2.36-8"	B	±0.06mm	320mm	10mm	30mm	20mm	100mm	3.4mm
1120-300B	60-300mm/2.36-12"	B	±0.07mm	420mm	10mm	30mm	20mm	110mm	3.4mm

IP67 dust/waterproof, no automatic power off, set zero after power on each time,
no preset (need to add the width of the jaws on the reading), without data interface

Code	Range	Type	Accuracy	L	a	b	c	d	e
1120-150P	22-150mm/0.87-6"	C	±0.04mm	250mm	5mm	11mm	16mm	30mm	1mm

DIGITAL INSIDE POINT CALIPERS

DATA OUTPUT

2

depth stop 6143 (optional)



1121-150A type A



1121-150B type B

- Measure groove diameter
- Resolution: 0.01mm/0.0005"
- Buttons type A: on/off, set, mm/inch, preset (+, -)
type B: on/off, zero, mm/inch
- Automatic power off, move the digital unit to turn on power
- Battery CR2032
- Data output
- Made of stainless steel
- Optional accessory: depth stop (code 6143, for calipers with c=16mm)

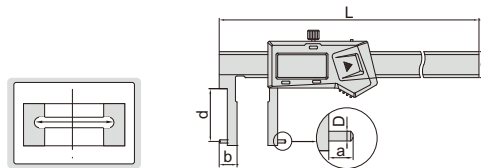

Preset (no need to add the width of the jaws on the reading), with data interface

(mm)

Code	Range	Type	Accuracy	L	a	b	c	d	D	Data output cable (optional)
1121-150A	24-150mm/0.94-6"	A	±0.04mm	250	5	12	16	28	Ø2	7315-21, 7302-21
1121-1501	35-150mm/1.38-6"	A	±0.05mm	250	6	17.5	16	60	Ø2	7315-21, 7302-21
1121-200A	25-200mm/0.98-8"	A	±0.04mm	310	5	12.5	16	37	Ø2	7315-21, 7302-21
1121-2001	40-200mm/1.57-8"	A	±0.05mm	310	7	20	16	70	Ø3	7315-21, 7302-21
1121-300A	30-300mm/1.18-12"	A	±0.07mm	410	5	15	16	50	Ø2	7315-21, 7302-21
1121-3001A	50-300mm/1.97-12"	A	±0.07mm	410	8	25	16	77	Ø3	7315-21, 7302-21
1121-500A	40-500mm/1.57-20"	A	±0.07mm	680	5	20	24	90	Ø3	7315-22, 7302-22
1121-5001	60-500mm/2.36-20"	A	±0.08mm	680	10	30	24	120	Ø3	7315-22, 7302-22
1121-5002	80-500mm/3.15-20"	A	±0.08mm	680	16	40	24	150	Ø3	7315-22, 7302-22

Preset (no need to add the width of the jaws on the reading), built-in wireless (receiver code 7315-2/3/6/7/8 is required)

Code	Range	Type	Accuracy	L	a	b	c	d	D
1121-150AWL	24-150mm/0.94-6"	A	±0.04mm	250mm	5mm	12mm	16mm	28mm	Ø2mm
1121-1501WL	35-150mm/1.38-6"	A	±0.05mm	250mm	6mm	17.5mm	16mm	60mm	Ø2mm
1121-200AWL	25-200mm/0.98-8"	A	±0.04mm	310mm	5mm	12.5mm	16mm	37mm	Ø2mm
1121-2001WL	40-200mm/1.57-8"	A	±0.05mm	310mm	7mm	20mm	16mm	70mm	Ø3mm
1121-300AWL	30-300mm/1.18-12"	A	±0.07mm	410mm	5mm	15mm	16mm	50mm	Ø2mm
1121-3001AWL	50-300mm/1.97-12"	A	±0.07mm	410mm	8mm	25mm	16mm	77mm	Ø3mm
1121-500AWL	40-500mm/1.57-20"	A	±0.07mm	680mm	5mm	20mm	24mm	90mm	Ø3mm
1121-5001WL	60-500mm/2.36-20"	A	±0.08mm	680mm	10mm	30mm	24mm	120mm	Ø3mm
1121-5002WL	80-500mm/3.15-20"	A	±0.08mm	680mm	16mm	40mm	24mm	150mm	Ø3mm

No preset (need to add the width of the jaws on the reading)

Code	Range	Type	Accuracy	L	a	b	c	d	D
1121-150B	50-150mm/1.97-6"	B	±0.06mm	270mm	8mm	25mm	20mm	90mm	Ø3mm
1121-200B	60-200mm/2.36-8"	B	±0.06mm	320mm	10mm	30mm	20mm	100mm	Ø3mm
1121-300B	60-300mm/2.36-12"	B	±0.07mm	420mm	10mm	30mm	20mm	110mm	Ø3mm

INSIDE GROOVE VERNIER CALIPER

- Measure diameter of grooves inside bores
- Made of stainless steel
- Satin chrome plated reading surface



1262-150A

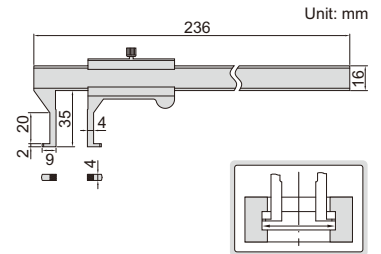

Code	Range	Graduation	Accuracy
1262-150A	18-150mm	0.02mm	±0.04mm

DIGITAL INSIDE GROOVE CALIPERS

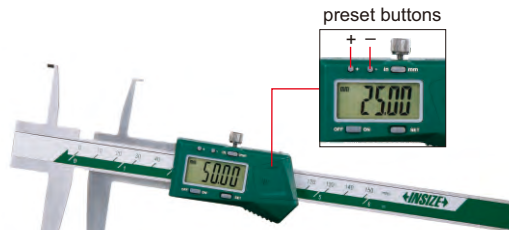

1176-150



1176-150P

depth stop 6143 (optional)

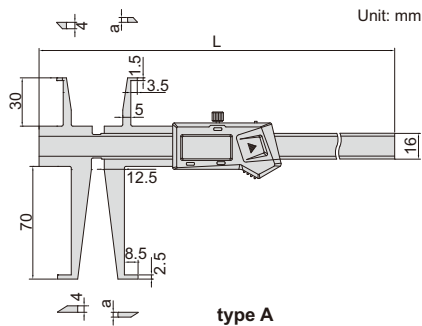

type A

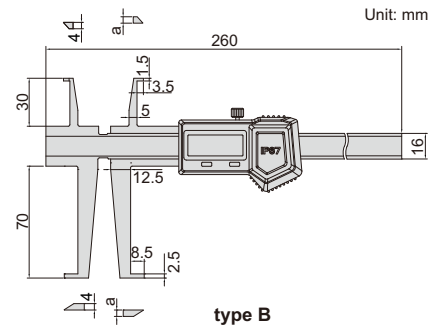

type B

- Measure diameter of grooves inside bores
- Resolution: 0.01mm/0.0005"
- Buttons type A: on/off, set, mm/inch, preset (+, -)
type B: on/off, zero, mm/inch, ABS/REL, hold
- Battery CR2032
- Made of stainless steel
- Optional accessory: depth stop (code 6143)

sizes to be measured (use upper jaws)

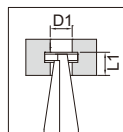

(mm)	
D1	L1
Ø9	<8
Ø10	<15
Ø11~200	<30

sizes to be measured (use lower jaws)

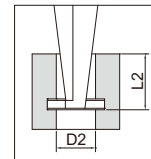

(mm)	
D2	L2
Ø17	<16
Ø18	<28
Ø19	<40
Ø20	<50
Ø21	<58
Ø22~200	<70

No dust/waterproof, with data interface (data output cable code 7315-21, 7302-21, optional)

Code	Range of upper jaw	Range of lower jaw	Type	Accuracy	L	a
1176-150	9-150mm/0.35-6"	17-150mm/0.70-6"	A	±0.04mm	260mm	3mm
1176-200	9-200mm/0.35-8"	17-200mm/0.70-8"	A	±0.05mm	320mm	3.5mm

No dust/waterproof, built-in wireless (receiver code 7315-2/3/6/7/8 is required)

Code	Range of upper jaw	Range of lower jaw	Type	Accuracy	L	a
1176-150WL	9-150mm/0.35-6"	17-150mm/0.70-6"	A	±0.04mm	260mm	3mm
1176-200WL	9-200mm/0.35-8"	17-200mm/0.70-8"	A	±0.05mm	320mm	3.5mm

IP67 dust/waterproof, without data interface, no automatic power off, set zero after power on each time

Code	Range of upper jaw	Range of lower jaw	Type	Accuracy	a
1176-150P	9-150mm/0.35-6"	17-150mm/0.70-6"	B	±0.04mm	4mm

INSIDE GROOVE CALIPER

2

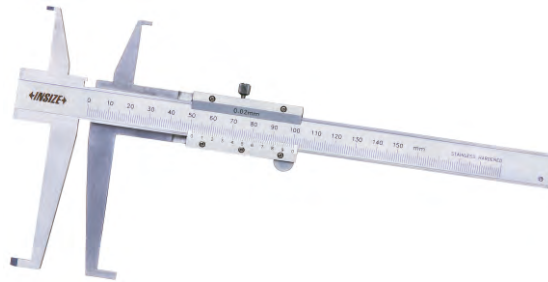

1199-150

depth stop 6143 (optional)

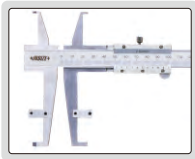

- Measure diameter of grooves inside bores
- Graduation: 0.02mm
- Made of stainless steel
- Optional accessory: depth stop (code 6143)

sizes to be measured (use upper jaws)

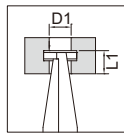

D1 (mm)	
Ø11	<8
Ø12	<10
Ø13	<15
Ø14	<20
Ø15~150	<30

sizes to be measured (use lower jaws)

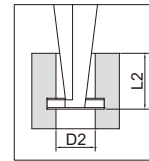

D2 (mm)	
Ø18	<20
Ø19	<28
Ø20	<35
Ø21	<40
Ø22	<50
Ø23~150	<70

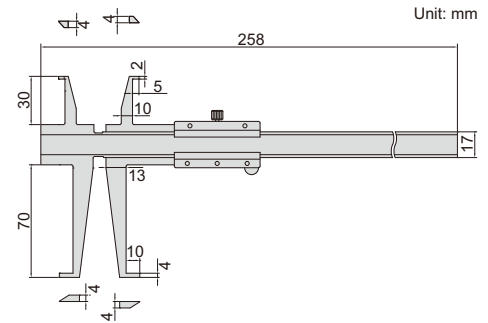

Unit: mm

Code	Range of upper jaw	Range of lower jaw	Accuracy
1199-150	11-150mm	18-150mm	±0.03mm

DIGITAL DEEP HOLE INSIDE GROOVE CALIPERS

DATA OUTPUT

preset buttons



1129-300

- Measure diameter of grooves inside deep holes
- Resolution: 0.01mm/0.0005"
- Buttons: on/off, set, mm/inch, preset (+, -)
- Automatic power off, move the digital unit to turn on power
- Battery CR2032
- Made of stainless steel
- Optional accessory: depth stop (code 6143)

depth stop 6143 (optional)

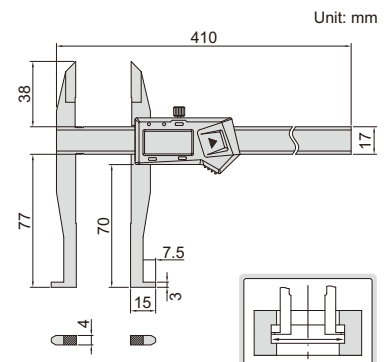

Unit: mm

With data interface (data output cable code 7315-21, 7302-21, optional)

Code	Range of upper jaw	Range of lower jaw	Accuracy
1129-300	0-300mm/0-12"	30-300mm/1.2-12"	±0.04mm

Built-in wireless (receiver code 7315-2/3/6/7/8 is required)

Code	Range of upper jaw	Range of lower jaw	Accuracy
1129-300WL	0-300mm/0-12"	30-300mm/1.2-12"	±0.04mm

DIGITAL INSIDE GROOVE CALIPERS

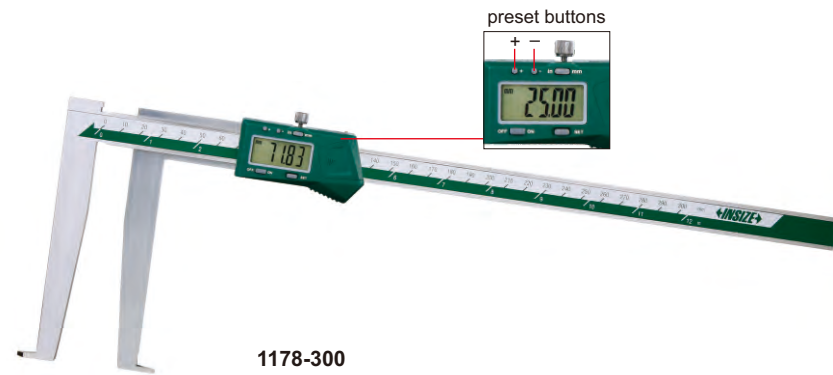

1178-300

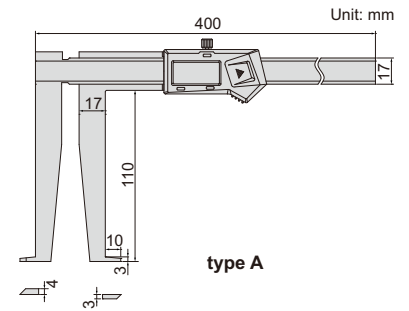

type A



1178-300P

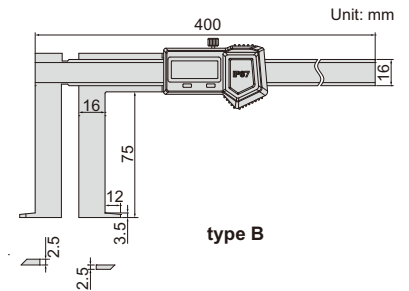

type B

- Measure diameter of grooves inside bores
- Resolution: 0.01mm/0.0005"
- Buttons type A: on/off, set, mm/inch, preset (+, -)
type B: on/off, zero, mm/inch, ABS/REL, hold
- Battery CR2032
- Made of stainless steel
- Optional accessory: depth stop (code 6143)

depth stop 6143 (optional)



No dust/waterproof, with data interface (data output cable code 7315-21, 7302-21, optional)

Code	Range	Type	Accuracy
1178-300	25-300mm/1.18-12"	A	±0.05mm

No dust/waterproof, built-in wireless (receiver code 7315-2/3/6/7/8 is required)

Code	Range	Type	Accuracy
1178-300WL	25-300mm/1.18-12"	A	±0.05mm

IP67 dust/waterproof, no automatic power off, set zero after power on each time, without data interface

Code	Range	Type	Accuracy
1178-300P	33-300mm/1.30-12"	B	±0.05mm

DATA OUTPUT

DIGITAL INSIDE GROOVE CALIPERS

- Measure diameter or distance of grooves
- Resolution: 0.01mm/0.0005"
- Buttons: on/off, set, mm/inch, preset (+, -)
- Automatic power off, move the digital unit to turn on power
- Battery CR2032
- Made of stainless steel



1128-200

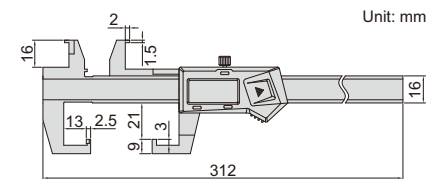

With data interface (data output cable code 7315-21, 7302-21, optional)

Code	Range of upper jaw	Range of lower jaw	Accuracy
1128-200	10-200mm/0.39-8"	3-200mm/0.12-8"	±0.03mm

Built-in wireless (receiver code 7315-2/3/6/7/8 is required)

Code	Range of upper jaw	Range of lower jaw	Accuracy
1128-200WL	10-200mm/0.39-8"	3-200mm/0.12-8"	±0.03mm

preset buttons

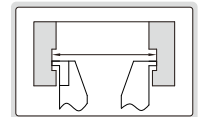
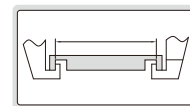
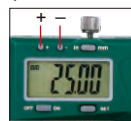

DIGITAL INSIDE GROOVE CALIPERS

DATA OUTPUT

2

- Upper jaws for measuring diameter of grooves
- Resolution: 0.01mm/0.0005"
- Buttons: on/off, zero, mm/inch
- Automatic power off, move the digital unit to turn on power
- Battery CR2032
- Made of stainless steel

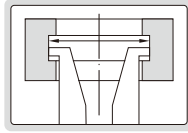

1191-150

With data interface (data output cable code 7315-21, 7302-21, optional)

Code	Range of upper jaw	Range of lower jaw	Accuracy
1191-150	8-150mm/0.3-6"	0-150mm/0-6"	±0.03mm

Built-in wireless (receiver code 7315-2/3/6/7/8 is required)

Code	Range of upper jaw	Range of lower jaw	Accuracy
1191-150WL	8-150mm/0.3-6"	0-150mm/0-6"	±0.03mm

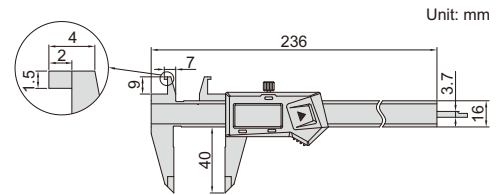

DIGITAL OUTSIDE NECK CALIPERS

DATA OUTPUT

- Measure grooves and recesses
- Resolution: 0.01mm/0.0005"
- Buttons: on/off, zero, mm/inch
- Automatic power off, move the digital unit to turn on power
- Battery CR2032
- Made of stainless steel
- Optional accessory: depth stop (code 6143, for calipers with e=16mm)



1187-150A

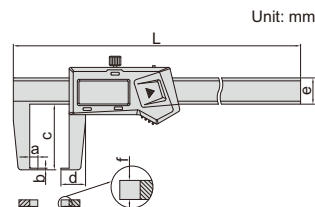
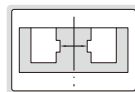

depth stop 6143 (optional)



With data interface

(mm)

Code	Range	Accuracy	L	a	b	c	d	e	f	Data output cable (optional)
1187-150A	0-150mm/0-6"	±0.04mm	250	5	1	40	15	16	4	7315-21, 7302-21
1187-200A	0-200mm/0-8"	±0.05mm	310	9	1.5	80	23	16	4	7315-21, 7302-21
1187-300A	0-300mm/0-12"	±0.06mm	490	12	2	150	36	24	4	7315-22, 7302-22
1187-500A	0-500mm/0-20"	±0.07mm	690	12	2	150	36	24	5.5	7315-22, 7302-22

Built-in wireless (receiver code 7315-2/3/6/7/8 is required)

Code	Range	Accuracy	L	a	b	c	d	e	f
1187-150AWL	0-150mm/0-6"	±0.04mm	250mm	5mm	1mm	40mm	15mm	16mm	4mm
1187-200AWL	0-200mm/0-8"	±0.05mm	310mm	9mm	1.5mm	80mm	23mm	16mm	4mm
1187-300AWL	0-300mm/0-12"	±0.06mm	490mm	12mm	2mm	150mm	36mm	24mm	4mm
1187-500AWL	0-500mm/0-20"	±0.07mm	690mm	12mm	2mm	150mm	36mm	24mm	5.5mm

DATA OUTPUT

DIGITAL OUTSIDE POINT CALIPERS

- Measure wall thickness inside bores and recesses
- Resolution: 0.01mm/0.0005"
- Buttons: on/off, zero, mm/inch
- Automatic power off, move the digital unit to turn on power
- Battery CR2032
- Made of stainless steel
- Optional accessory: depth stop (code 6143)



1185-150A

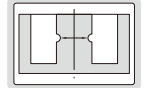
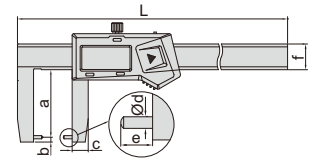

With data interface

Code	Range	Accuracy	L	a	b	c	Ød	e	f	Data output cable (optional)
1185-150A	0-150mm/0-6"	±0.04mm	250	40	3	10	2	5	16	7315-21, 7302-21
1185-200A	0-200mm/0-8"	±0.05mm	310	80	3	14	3	9	16	7315-21, 7302-21
1185-300A	0-300mm/0-12"	±0.06mm	490	150	3	20	3	12	24	7315-22, 7302-22

(mm)

Built-in wireless (receiver code 7315-2/3/6/7/8 is required)

Code	Range	Accuracy	L	a	b	c	Ød	e	f
1185-150AWL	0-150mm/0-6"	±0.04mm	250	40	3	10	2	5	16
1185-200AWL	0-200mm/0-8"	±0.05mm	310	80	3	14	3	9	16
1185-300AWL	0-300mm/0-12"	±0.06mm	490	150	3	20	3	12	24

(mm)

depth stop 6143 (optional)



DATA OUTPUT

DIGITAL OUTSIDE GROOVE CALIPERS

- Measure grooves and recesses in small spaces
- Resolution: 0.01mm/0.0005"
- Buttons: on/off, zero, mm/inch
- Automatic power off, move the digital unit to turn on power
- Battery CR2032
- Made of stainless steel



1535-100

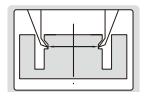
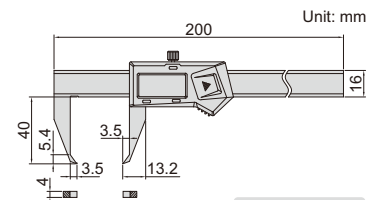

With data interface (data output cable code 7315-21, 7302-21, optional)

Code	Range	Accuracy
1535-100	0-100mm/0-4"	±0.03mm



Built-in wireless (receiver code 7315-2/3/6/7/8 is required)

Code	Range	Accuracy
1535-100WL	0-100mm/0-4"	±0.03mm

DEPTH STOP FOR CALIPERS

application

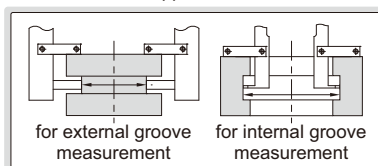

6143

Code
6143

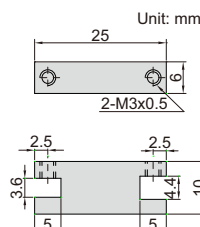

- Supplied in pair
- Made of stainless steel
- Suitable for caliper series 1124, 1526, 1530, 1520, 1176, 1178, 1120, 1121, 1187, 1129 and 1185

DIGITAL CALIPERS WITH POSITIONING SURFACES

DATA OUTPUT

- Lower jaws with positioning surfaces, for measuring inside diameters quickly
- Resolution: 0.01mm/0.0005"
- Buttons: on/off, set, mm/inch, preset (+, -)
- Automatic power off, move the digital unit to turn on power
- Battery CR2032
- Made of stainless steel



1534-200



preset buttons

With data interface (data output cable code 7315-21, 7302-21, optional)

Code	Range	Accuracy
1534-200	0-200mm/0-8"	±0.03mm

Built-in wireless (receiver code 7315-2/3/6/7/8 is required)

Code	Range	Accuracy
1534-200WL	0-200mm/0-8"	±0.03mm

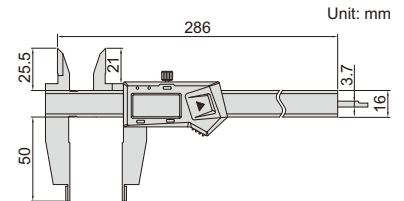
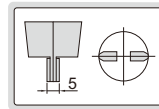
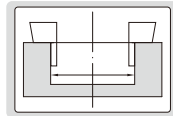

DIGITAL BLADE CALIPERS

DATA OUTPUT

- The blade jaws fit into small grooves
- Resolution: 0.01mm/0.0005"
- Buttons: on/off, zero, mm/inch
- Automatic power off, move the digital unit to turn on power
- Battery CR2032
- Made of stainless steel



1188-150A

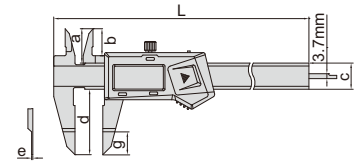

With data interface (data output cable code 7315-21, 7302-21, optional)

Code	Range	Accuracy	L	a	b	c	d	e	g
1188-150A	0-150mm/0-6"	±0.03mm	235mm	21mm	16.5mm	16mm	40mm	0.85mm	17mm
1188-200A	0-200mm/0-8"	±0.03mm	297mm	24mm	20mm	16mm	50mm	0.85mm	17mm
1188-300A	0-300mm/0-12"	±0.04mm	390mm	26mm	21.5mm	16mm	60mm	1.00mm	17mm

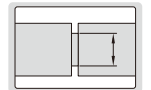

Built-in wireless (receiver code 7315-2/3/6/7/8 is required)

Code	Range	Accuracy	L	a	b	c	d	e	g
1188-150AWL	0-150mm/0-6"	±0.03mm	235mm	21mm	16.5mm	16mm	40mm	0.85mm	17mm
1188-200AWL	0-200mm/0-8"	±0.03mm	297mm	24mm	20mm	16mm	50mm	0.85mm	17mm
1188-300AWL	0-300mm/0-12"	±0.04mm	390mm	26mm	21.5mm	16mm	60mm	1.00mm	17mm

DIGITAL SMALL POINT CALIPERS

DATA OUTPUT

- Small pointed jaws fit into small grooves and recesses
- Resolution: 0.01mm/0.0005"
- Buttons: on/off, zero, mm/inch
- Automatic power off, move the digital unit to turn on power
- Battery CR2032
- Made of stainless steel



1169-150

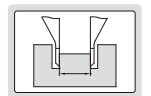

With data interface (data output cable code 7315-21, 7302-21, optional)

Code	Range	Accuracy
1169-150	0-150mm/0-6"	±0.03mm

Built-in wireless (receiver code 7315-2/3/6/7/8 is required)

Code	Range	Accuracy
1169-150WL	0-150mm/0-6"	±0.03mm

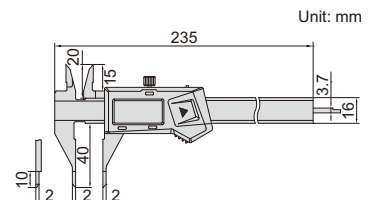

DIGITAL POINT CALIPERS

- Pointed jaws fit into small grooves and recesses
- Resolution: 0.01mm/0.0005"
- Buttons: on/off, zero, mm/inch
- Automatic power off, move the digital unit to turn on power
- Battery CR2032
- Made of stainless steel



1183-150A

DATA OUTPUT

2

With data interface (data output cable code 7315-21, 7302-21, optional)

Code	Range	Accuracy	L	a	b	c
1183-150A	0-150mm/0-6"	±0.03mm	236mm	40mm	21mm	16.5mm
1183-200A	0-200mm/0-8"	±0.03mm	286mm	50mm	24mm	19.5mm
1183-300A	0-300mm/0-12"	±0.03mm	400mm	60mm	25mm	21.5mm

Built-in wireless (receiver code 7315-2/3/6/7/8 is required)

Code	Range	Accuracy	L	a	b	c
1183-150AWL	0-150mm/0-6"	±0.03mm	236mm	40mm	21mm	16.5mm
1183-200AWL	0-200mm/0-8"	±0.03mm	286mm	50mm	24mm	19.5mm
1183-300AWL	0-300mm/0-12"	±0.03mm	400mm	60mm	25mm	21.5mm

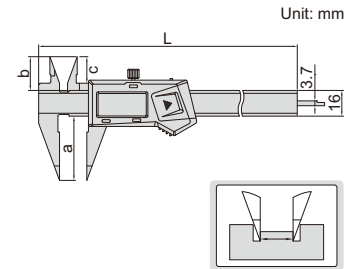

DATA OUTPUT

DIGITAL CALIPERS WITH KNIFE EDGE LOWER JAWS

- Measure diameter of narrow grooves
- Resolution: 0.01mm/0.0005"
- Buttons: on/off, zero, mm/inch
- Automatic power off, move the digital unit to turn on power
- Battery CR2032
- Made of stainless steel



1532-200

With data interface (data output cable code 7315-21, 7302-21, optional)

Code	Range	Accuracy
1532-200	0-200mm/0-8"	±0.03mm

Built-in wireless (receiver code 7315-2/3/6/7/8 is required)

Code	Range	Accuracy
1532-200WL	0-200mm/0-8"	±0.03mm

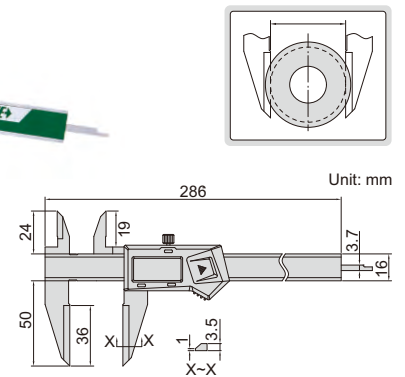

DATA OUTPUT

DIGITAL INSIDE KNIFE-EDGE CALIPERS

- Measure diameter of deep step holes
- Resolution: 0.01mm/0.0005"
- Buttons: on/off, zero, mm/inch
- Automatic power off, move the digital unit to turn on power
- Battery CR2032
- Made of stainless steel



1123-150A

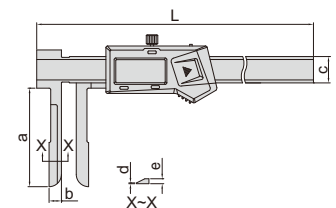

With data interface

Code	Range	Accuracy	L	a	b	c	d	e	Data output cable (optional)
1123-150A	15-150mm/0.6-6"	±0.05mm	250	60	12	16	0.3	3.5	7315-21, 7302-21
1123-200A	20-200mm/0.8-8"	±0.06mm	305	100	17	16	0.3	3.5	7315-21, 7302-21
1123-300A	24-300mm/0.9-12"	±0.06mm	500	150	22	24	0.5	3.5	7315-22, 7302-22

Built-in wireless (receiver code 7315-2/3/6/7/8 is required)

Code	Range	Accuracy	L	a	b	c	d	e
1123-150AWL	15-150mm/0.6-6"	±0.05mm	250	60	12	16	0.3	3.5
1123-200AWL	20-200mm/0.8-8"	±0.06mm	305	100	17	16	0.3	3.5

DIGITAL CALIPERS WITH LONG UPPER JAWS

DATA OUTPUT

- Long upper jaws for measuring diameter of deep holes
- Resolution: 0.01mm/0.0005"
- Buttons: on/off, zero, mm/inch
- Automatic power off, move the digital unit to turn on power
- Battery CR2032
- Made of stainless steel



1138-200

With data interface (data output cable code 7315-21, 7302-21, optional)

Code	Range	Accuracy
1138-200	0-200mm/0-8"	±0.04mm

Built-in wireless (receiver code 7315-2/3/6/7/8 is required)

Code	Range	Accuracy
1138-200WL	0-200mm/0-8"	±0.04mm

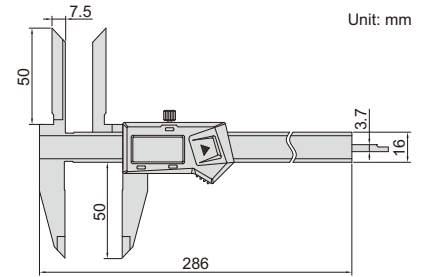
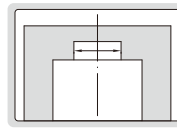

DIGITAL OFFSET CENTERLINE CALIPERS

DATA OUTPUT

preset buttons



1192-150A

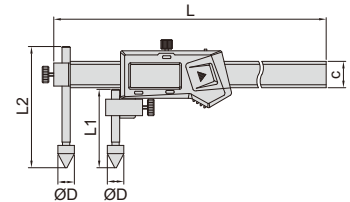

- Measure hole center distance in the same or offset planes
- Resolution: 0.01mm/0.0005"
- Buttons: on/off, set, mm/inch, preset (+, -)
- Automatic power off, move the digital unit to turn on power
- Battery CR2032
- Made of stainless steel

With data interface

Code	Range	Accuracy	c	ØD	L1	L2	L	Data output cable (optional)
1192-150A	10-150mm/0.4-6"	±0.05mm	16	10	46	79	236	7315-21, 7302-21
1192-200A	10-200mm/0.4-8"	±0.07mm	16	10	46	79	286	7315-21, 7302-21
1192-300A	10-300mm/0.4-12"	±0.09mm	16	10	46	79	396	7315-21, 7302-21
1192-500A	20-500mm/0.8-20"	±0.09mm	24	20	52	112	725	7315-22, 7302-22
1192-1000A	30-1000mm/1.2-40"	±0.12mm	31	30	52	112	1255	7315-22, 7302-22
1192-1500A	30-1500mm/1.2-60"	±0.15mm	42	30	52	112	1805	—

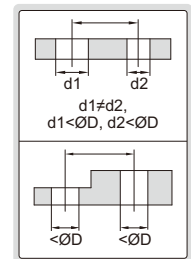

Built-in wireless (receiver code 7315-2/3/6/7/8 is required)

Code	Range	Accuracy	c	ØD	L1	L2	L
1192-150AWL	10-150mm/0.4-6"	±0.05mm	16	10	46	79	236
1192-200AWL	10-200mm/0.4-8"	±0.07mm	16	10	46	79	286
1192-300AWL	10-300mm/0.4-12"	±0.09mm	16	10	46	79	396
1192-500AWL	20-500mm/0.8-20"	±0.09mm	24	20	52	112	725

DATA OUTPUT

DIGITAL BACK-JAW CENTERLINE CALIPERS

- Measure hole center distance in the same or offset planes
- Resolution: 0.01mm/0.0005"
- Buttons: on/off, set, mm/inch, preset (+, -)
- Automatic power off, move the digital unit to turn on power
- Battery CR2032
- Made of stainless steel



1177-200

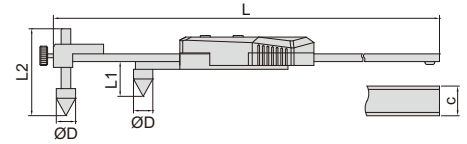

With data interface

Code	Range	Accuracy	ØD	c	L1	L2	L	Data output cable (optional)
1177-200	10-200mm/0.4-8"	±0.10mm	10	16	18	45	310	7315-21, 7302-21
1177-300	10-300mm/0.4-12"	±0.10mm	10	16	18	45	410	7315-21, 7302-21
1177-500	20-500mm/0.8-20"	±0.10mm	20	24	26	70	692	7315-22, 7302-22
1177-1000	30-1000mm/1.2-40"	±0.12mm	30	31	39	70	1242	7315-22, 7302-22
1177-1500	30-1500mm/1.2-60"	±0.15mm	30	31	39	70	1745	7315-22, 7302-22

(mm)

back-jaw



Built-in wireless (receiver code 7315-2/3/6/7/8 is required)

(mm)

Code	Range	Accuracy	ØD	c	L1	L2	L
1177-200WL	10-200mm/0.4-8"	±0.10mm	10	16	18	45	310
1177-300WL	10-300mm/0.4-12"	±0.10mm	10	16	18	45	410
1177-500WL	20-500mm/0.8-20"	±0.10mm	20	24	26	70	692

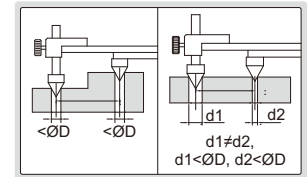

DATA OUTPUT

DIGITAL CENTERLINE AND EDGE TO CENTER CALIPERS



1525-300

- Measure hole center distance or edge to hole center distance
- Resolution: 0.01mm/0.0005"
- Buttons: on/off, set, mm/inch, preset (+, -)
- Automatic power off, move the digital unit to turn on power
- Battery CR2032
- Made of stainless steel

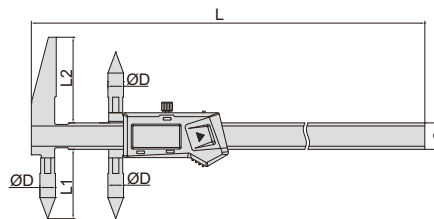

measure edge to hole center distance

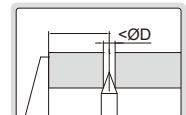

measure hole center distance

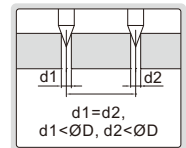

With data interface

(mm)

Code	Range of upper jaw (edge to center)	Range of lower jaw (center to center)	Accuracy	ØD	L1	L2	c	L	Data output cable (optional)
1525-300	5-300mm/0.2-12"	10-300mm/0.4-12"	±0.08mm	10	44.5	55	17	410	7315-21, 7302-21
1525-3001	10-300mm/0.4-12"	20-300mm/0.8-12"	±0.08mm	20	48	60	17	410	7315-21, 7302-21
1525-500	10-500mm/0.4-20"	20-500mm/0.8-20"	±0.09mm	20	50	60	24	690	7315-22, 7302-22
1525-1000	15-1000mm/0.6-40"	30-1000mm/1.2-40"	±0.12mm	30	70	81	31	1255	7315-22, 7302-22
1525-1500	15-1500mm/0.6-60"	30-1500mm/1.2-60"	±0.15mm	30	70	81	31	1760	7315-22, 7302-22

Built-in wireless (receiver code 7315-2/3/6/7/8 is required)

(mm)

Code	Range of upper jaw (edge to center)	Range of lower jaw (center to center)	Accuracy	ØD	L1	L2	c	L
1525-300WL	5-300mm/0.2-12"	10-300mm/0.4-12"	±0.08mm	10	44.5	55	17	410
1525-3001WL	10-300mm/0.4-12"	20-300mm/0.8-12"	±0.08mm	20	48	60	17	410
1525-500WL	10-500mm/0.4-20"	20-500mm/0.8-20"	±0.09mm	20	50	60	24	690

DIGITAL BACK-JAW EDGE TO CENTER CALIPERS

DATA OUTPUT

- Measure edge to hole center distance
- Resolution: 0.01mm/0.0005"
- Buttons: on/off, set, mm/inch, preset (+, -)
- Automatic power off, move the digital unit to turn on power
- Battery CR2032
- Made of stainless steel

With data interface
(data output cable code 7315-21, 7302-21, optional)

Code	Range	Accuracy	L
1524-200	5-200mm/0.2-8"	±0.1mm	310mm
1524-300	5-300mm/0.2-12"	±0.1mm	410mm

Built-in wireless
(receiver code 7315-2/3/6/7/8 is required)

Code	Range	Accuracy	L
1524-200WL	5-200mm/0.2-8"	±0.1mm	310mm
1524-300WL	5-300mm/0.2-12"	±0.1mm	410mm

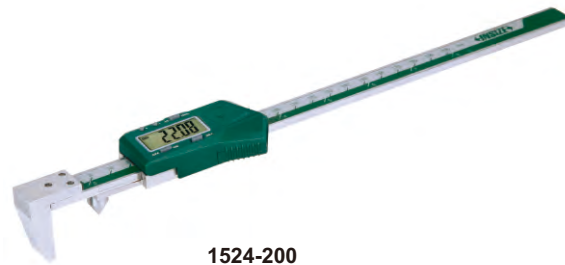

1524-200



preset buttons

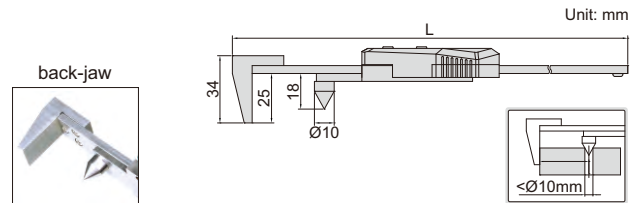

DIGITAL HOOK CALIPERS

DATA OUTPUT



1122-300

- Measure width and distance of grooves inside bores
- Resolution: 0.01mm/0.0005"
- Buttons: on/off, zero, mm/inch
- Automatic power off, move the digital unit to turn on power
- Battery CR2032
- Made of stainless steel

With data interface (data output cable code 7315-21, 7302-21, optional)

Code	Range	Accuracy
1122-300	4-300mm/0.16-12"	±0.04mm

Built-in wireless
(receiver code 7315-2/3/6/7/8 is required)

Code	Range	Accuracy
1122-300WL	4-300mm/0.16-12"	±0.04mm

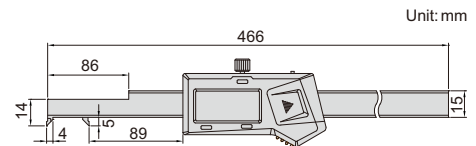

Unit: mm

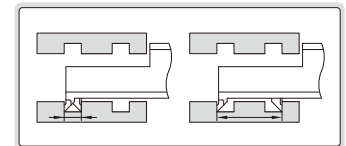

DIGITAL ARC RADIUS CALIPERS

DATA OUTPUT

- Measure the radius of arc less than half round
- Resolution: 0.01mm/0.0005"
- Buttons: on/off, zero, mm/inch
- Automatic power off, move the digital unit to turn on power
- Battery CR2032
- Made of stainless steel



1189-200B

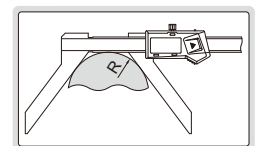

With data interface (data output cable code 7315-21, 7302-21, optional)

Code	Range (R)	Accuracy	L	c	d
1189-150B	5-150mm/0.2-6"	±0.05mm	263mm	16mm	65mm
1189-200B	5-200mm/0.2-8"	±0.07mm	313mm	16mm	85mm

Built-in wireless (receiver code 7315-2/3/6/7/8 is required)

Code	Range (R)	Accuracy	L	c	d
1189-150BWL	5-150mm/0.2-6"	±0.05mm	263mm	16mm	65mm
1189-200BWL	5-200mm/0.2-8"	±0.07mm	313mm	16mm	85mm

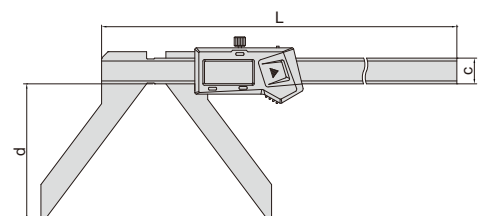

DATA
OUTPUT

DIGITAL CALIPERS WITH ONE DIRECTION UPPER JAWS

2



1184-200



1184-150A

- Resolution: 0.01mm/0.0005"
- Buttons: zero, power on/off, inch/mm
- Automatic power off, move the digital unit to turn on power
- Battery CR2032
- Data output
- Made of stainless steel
- Optional accessory: data output cable (code 7315-21, 7302-21)

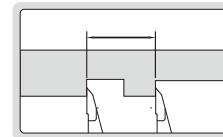
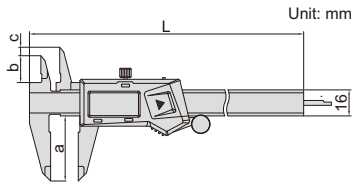

jaws with same height used for measuring the distance in same level

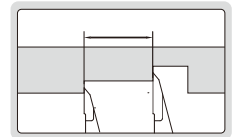

jaws with different height used for measuring the distance in different level

Jaws with same height (mm)

Code	Range	Accuracy	L	a	b	c
1184-150	0-150mm/0-6"	±0.03mm	236	40	17	0
1184-200	0-200mm/0-8"	±0.03mm	286	50	20	0
1184-300	0-300mm/0-12"	±0.03mm	400	60	22	0

Jaws with different height (mm)

Code	Range	Accuracy	L	a	b	c
1184-150A	0-150mm/0-6"	±0.03mm	236	40	17	5
1184-200A	0-200mm/0-8"	±0.03mm	286	50	20	8
1184-300A	0-300mm/0-12"	±0.03mm	400	60	22	10

DATA
OUTPUT

DIGITAL OFFSET CALIPERS



1186-150A

- The left jaw can slide up and down to facilitate measurement of stepped sections
- Resolution: 0.01mm/0.0005"
- Buttons: on/off, zero, mm/inch
- Automatic power off, move the digital unit to turn on power
- Battery CR2032
- Made of stainless steel

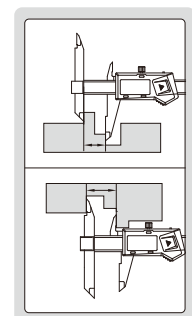
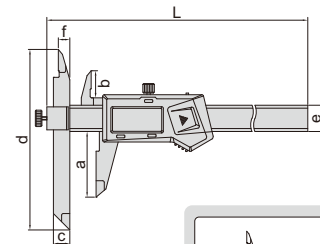

With data interface (data output cable code 7315-21, 7302-21, optional) (mm)

Code	Range	Accuracy	L	a	b	c	d	e	f
1186-150A	0-150mm/0-6"	±0.04mm	249	40	16.5	10	110	17	7
1186-200A	0-200mm/0-8"	±0.04mm	299	50	19.5	10	120	17	7
1186-300A	0-300mm/0-12"	±0.05mm	399	60	20.5	10	130	17	7

Built-in wireless (receiver code 7315-2/3/6/7/8 is required) (mm)

Code	Range	Accuracy	L	a	b	c	d	e	f
1186-150AWL	0-150mm/0-6"	±0.04mm	249	40	16.5	10	110	17	7
1186-200AWL	0-200mm/0-8"	±0.04mm	299	50	19.5	10	120	17	7
1186-300AWL	0-300mm/0-12"	±0.05mm	399	60	20.5	10	130	17	7

DIGITAL TUBE THICKNESS CALIPERS

DATA OUTPUT

- Measure wall thickness of tubes
- Resolution: 0.01mm/0.0005"
- Buttons: on/off, zero, mm/inch
- Automatic power off, move the digital unit to turn on power
- Battery CR2032
- Made of stainless steel



1161-150A

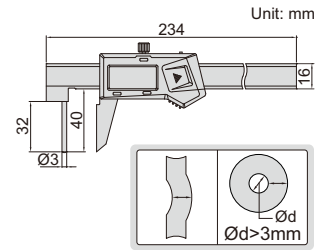

With data interface (data output cable code 7315-21, 7302-21, optional)

Code	Range	Accuracy
1161-150A	0-150mm/0-6"	±0.05mm

Built-in wireless (receiver code 7315-2/3/6/7/8 is required)

Code	Range	Accuracy
1161-150AWL	0-150mm/0-6"	±0.05mm

DIGITAL RTJ RING GROOVE CALIPERS

DATA OUTPUT

- Measure ring grooves of flange
- Resolution: 0.01mm/0.0005"
- Button function: on/off, set, zero, mm/inch, data preset
- Battery CR2032
- Made of stainless steel

preset buttons

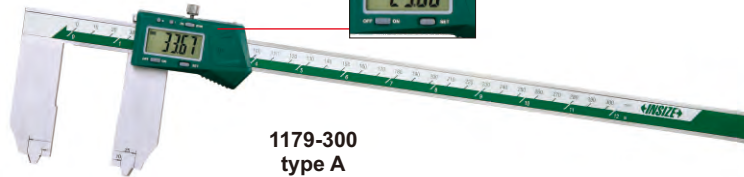

1179-300 type A

applicable for RTJ ring grooves with angle 23°

d and e need to be added on the reading

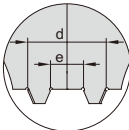
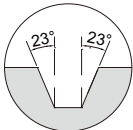

1179-600 type B

measure outside diameter of RTJ ring groove

measure inside diameter of RTJ ring groove

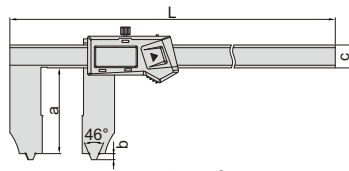
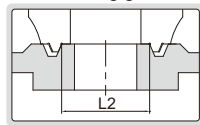
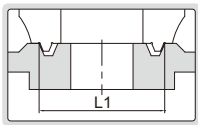

type A

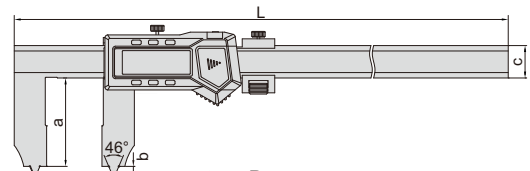

type B

With data interface

(mm)

Code	Range (inside diameter of RTJ ring groove)	Range (outside diameter of RTJ ring groove)	Angle of RTJ ring groove	Accuracy	Type	L	a	b	c	d	e	Data output cable (optional)
1179-300	10-300mm/0.4-12"	25-300mm/1-12"	23°	±0.06mm	A	410	63.5	4.5	17	25	10	7315-21, 7302-21
1179-600	10-600mm/0.4-24"	25-600mm/1-24"	23°	±0.07mm	B	770	65.5	4.5	24	25	10	7315-22, 7302-22
1179-1000	15-1000mm/0.6-40"	30-1000mm/1.2-40"	23°	±0.09mm	B	1220	90	5	31	30	15	7315-22, 7302-22

Built-in wireless (receiver code 7315-2/3/6/7/8 is required)

(mm)

Code	Range (inside diameter of RTJ ring groove)	Range (outside diameter of RTJ ring groove)	Angle of RTJ ring groove	Accuracy	Type	L	a	b	c	d	e
1179-300WL	10-300mm/0.4-12"	25-300mm/1-12"	23°	±0.06mm	A	410	63.5	4.5	17	25	10
1179-600WL	10-600mm/0.4-24"	25-600mm/1-24"	23°	±0.07mm	B	770	65.5	4.5	24	25	10

DATA
OUTPUT

DIGITAL CALIPERS WITH INTERCHANGEABLE BALL TIPS



1527-3001

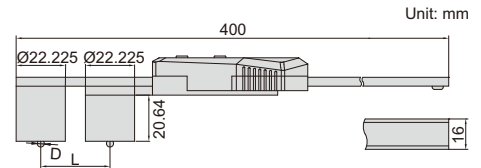

- Resolution 0.01mm/0.0005"
- Buttons: on/off, set, mm/inch, preset (+, -)
- Automatic power off, move the digital unit to turn on power
- Battery CR2032
- Made of stainless steel
- Optional accessory: ball tips

With data interface (data output cable code 7315-21, 7302-21, optional)

Code	Range	Accuracy
1527-3001	(22.22+D)~300mm*	±0.03mm

Built-in wireless (receiver code 7315-2/3/6/7/8 is required)

Code	Range	Accuracy
1527-3001WL	(22.22+D)~300mm*	±0.03mm

*"D" is the diameter of ball tips.

Ball tips (optional, supplied in pair)

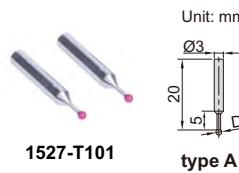

1527-T101

type A



1527-T104

type B

Code	Diameter (D)	Accuracy of diameter	Type	Material
1527-T101	1/16" (Ø1.5875mm)	±0.005mm	A	ruby
1527-T102	1/8" (Ø3.175mm)	±0.005mm	B	stainless steel
1527-T103	3/16" (Ø4.7625mm)	±0.005mm	B	stainless steel
1527-T104	1/4" (Ø6.35mm)	±0.005mm	B	stainless steel
1527-T105	3/8" (Ø9.525mm)	±0.005mm	B	stainless steel
1527-T106	1/2" (Ø12.7mm)	±0.005mm	B	stainless steel

 DATA
OUTPUT

DIGITAL CALIPERS WITH INTERCHANGEABLE BALL TIPS

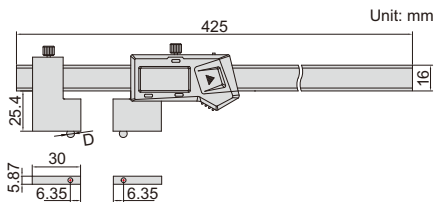

ball tips are optional

1528-3001



- Resolution 0.01mm/0.0005"
- Buttons: on/off, set, mm/inch, preset (+, -)
- Automatic power off, move the digital unit to turn on power
- Battery CR2032
- Made of stainless steel
- Optional accessory: ball tips

With data interface (data output cable code 7315-21, 7302-21, optional)

Code	Range	Accuracy
1528-3001	(12.7+D)~300mm*	±0.03mm

Built-in wireless (receiver code 7315-2/3/6/7/8 is required)

Code	Range	Accuracy
1528-3001WL	(12.7+D)~300mm*	±0.03mm

*"D" is the diameter of ball tips.

Ball tips (optional, supplied in pair)

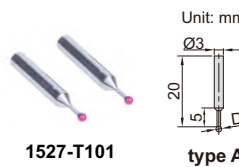

1527-T101

type A



1527-T104

type B

Code	Diameter (D)	Accuracy of diameter	Type	Material
1527-T101	1/16" (Ø1.5875mm)	±0.005mm	A	ruby
1527-T102	1/8" (Ø3.175mm)	±0.005mm	B	stainless steel
1527-T103	3/16" (Ø4.7625mm)	±0.005mm	B	stainless steel
1527-T104	1/4" (Ø6.35mm)	±0.005mm	B	stainless steel
1527-T105	3/8" (Ø9.525mm)	±0.005mm	B	stainless steel
1527-T106	1/2" (Ø12.7mm)	±0.005mm	B	stainless steel

DIGITAL CRIMP HEIGHT CALIPERS

RELATIVE PRODUCT: CRIMP HEIGHT MICROMETER (CODE 3266-25BA, 3566-25BA)

DATA OUTPUT

- Measure crimp height
- Resolution: 0.01mm/0.0005"
- Buttons: on/off, zero, mm/inch
- Automatic power off, move the digital unit to turn on power
- Battery CR2032, meet DIN862
- Made of stainless steel



1165-150A

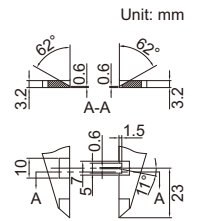

Unit: mm

With data interface (data output cable code 7315-21, 7302-21, optional)

Code	Range	Accuracy
1165-150A	0-150mm/0-6"	±0.03mm

Built-in wireless (receiver code 7315-2/3/6/7/8 is required)

Code	Range	Accuracy
1165-150AWL	0-150mm/0-6"	±0.03mm

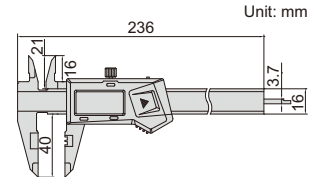

Unit: mm

DIGITAL CALIPERS WITH LARGE MEASURING FACES

DATA OUTPUT

- Measure diameter of wire ropes, and thickness of soft materials like rubber, sponge, etc.
- Resolution: 0.01mm/0.0005"
- Buttons: on/off, zero, mm/inch
- Automatic power off, move the digital unit to turn on power
- Battery CR2032
- Made of stainless steel

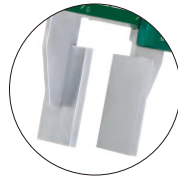

1172-200

With data interface (data output cable code 7315-21, 7302-21, optional)

Code	Range	Accuracy
1172-200	0-200mm/0-8"	±0.07mm

Built-in wireless (receiver code 7315-2/3/6/7/8 is required)

Code	Range	Accuracy
1172-200WL	0-200mm/0-8"	±0.07mm

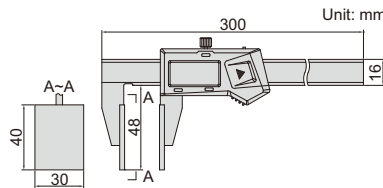

Unit: mm

measure diameter of wire ropes

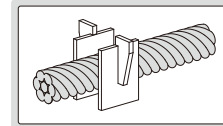

measure thickness of rubber, sponge, etc.

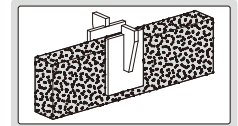

DIGITAL CALIPERS WITH DISK FACES

DATA OUTPUT

- Measure thickness of soft sheets
- Resolution: 0.01mm/0.0005"
- Buttons: on/off, zero, mm/inch
- Automatic power off, move the digital unit to turn on power
- Battery CR2032
- Made of stainless steel



1533-150

With data interface

Code	Range	Accuracy	L	a	b	c	Ød	Data output cable (optional)
1533-150	0-150mm/0-6"	±0.04mm	245	50	11	16	20	7315-21, 7302-21
1533-200	0-200mm/0-8"	±0.05mm	310	80	11	16	30	7315-21, 7302-21
1533-500	0-500mm/0-20"	±0.07mm	680	150	12.5	24	50	7315-22, 7302-22

Built-in wireless (receiver code 7315-2/3/6/7/8 is required)

Code	Range	Accuracy	L	a	b	c	Ød
1533-150WL	0-150mm/0-6"	±0.04mm	245	50	11	16	20
1533-200WL	0-200mm/0-8"	±0.05mm	310	80	11	16	30
1533-500WL	0-500mm/0-20"	±0.07mm	680	150	12.5	24	50

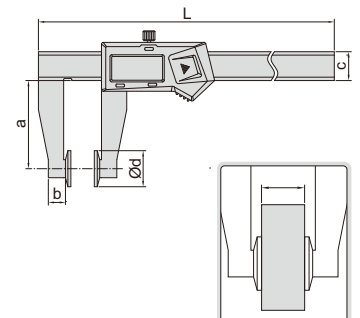

DATA
OUTPUT

DIGITAL WALL THICKNESS CALIPERS

2

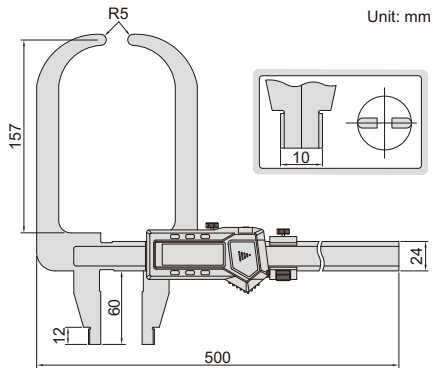

1536-300

- Measure wall thickness of helmets, domes and curved pots
- Resolution: 0.01mm/0.0005"
- Buttons: on/off, zero, mm/inch, ABS, data preset
- Automatic power off, move the digital unit to turn on power
- Battery CR2032
- Made of stainless steel

With data interface (data output cable code 7315-22, 7302-22, optional)

Code	Range	Accuracy
1536-300	0-300mm/0-12"	±0.05mm

Built-in wireless (receiver code 7315-2/3/6/7/8 is required)

Code	Range	Accuracy
1536-300WL	0-300mm/0-12"	±0.05mm

ATTENTION: ACTUAL DIAMETER IS 2/3 OF THE READING

DIGITAL V SHAPE CALIPER

- Measure outside diameter of three number of flutes (such as taps, reamers, end mills and gears)
- Resolution: 0.01mm/0.0005"
- Buttons: on/off, set, mm/inch, preset (+, -)
- Battery CR2032
- Automatic power off, move the digital unit to turn on power
- Data output
- Made of stainless steel



1539-3

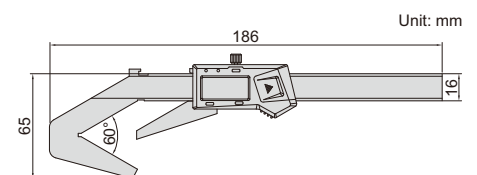

Code	Range	Accuracy
1539-3	Ø4-Ø40mm/0.16"-1.58" DIA	±0.03mm

V SHAPE VERNIER CALIPER

- Measure outside diameter of three number of flutes (such as taps, reamers, end mills and gears)
- Made of stainless steel
- Satin chrome plated reading surface



1273-403

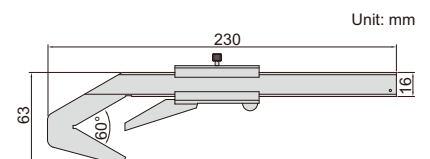

Code	Range	Graduation	Accuracy
1273-403	Ø4-40mm	0.05mm	±0.05mm

DIGITAL GEAR TOOTH CALIPERS

ATTENTION:
NO DATA OUTPUT

2

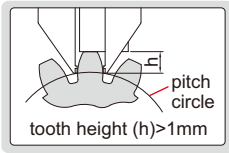

- Resolution: 0.01mm/0.0005"
- Carbide tips
- Measure the tooth thickness by positioning the tooth height (for tooth height > 1mm)
- Buttons: zero, on/off, mm/inch
- Automatic power off, move the digital unit to turn on power
- Battery CR2032
- Made of stainless steel



1181-M25A

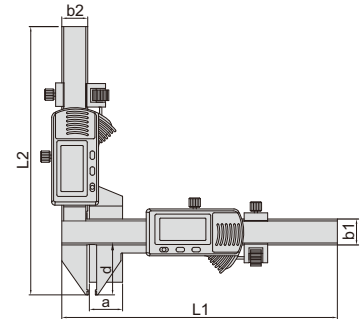

Code	Range	Accuracy of height measurement	Accuracy of thickness measurement	Total accuracy	L1	L2	a	b1	b2	d
1181-M25A	M1-25mm	±0.03mm	±0.03mm	±0.04mm	170mm	165.5mm	21mm	16mm	16mm	30.5mm
1181-M50A	M5-50mm	±0.03mm	±0.03mm	±0.04mm	220mm	190mm	50.5mm	16mm	16mm	55mm

GEAR TOOTH VERNIER CALIPER

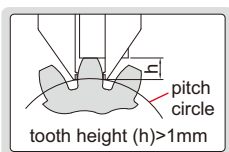

- Carbide tips
- Measure the tooth thickness by positioning the tooth height (for tooth height > 1mm)
- Made of stainless steel
- Satin chrome plated reading surface

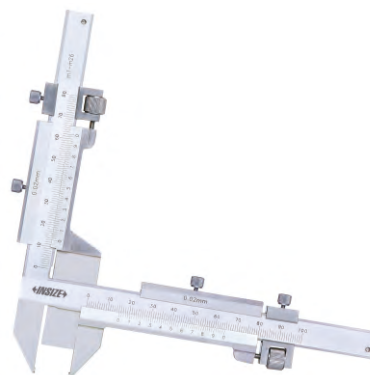

1281-M26A

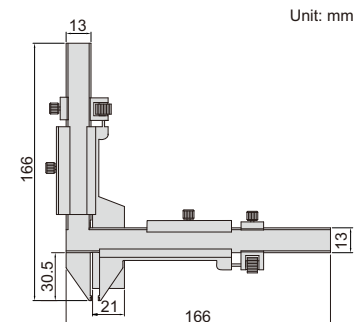

Unit: mm

Code	Range	Graduation	Accuracy of height measurement	Accuracy of thickness measurement	Total accuracy
1281-M26A	M1-26mm	0.02mm	±0.03mm	±0.03mm	±0.04mm

RELATIVE PRODUCT: DISK BRAKE MICROMETER (CODE 3288-, 3588-)

DATA OUTPUT

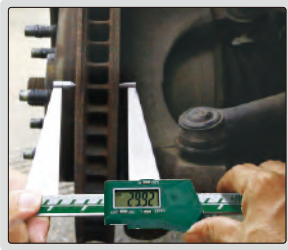

1162-125A

DIGITAL DISK BRAKE CALIPERS

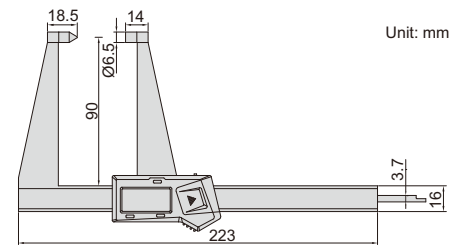

Unit: mm

With data interface (data output cable code 7315-21, 7302-21, optional)

Code	Range	Accuracy
1162-125A	0-125mm/0-5"	±0.05mm

Built-in wireless (receiver code 7315-2/3/6/7/8 is required)

Code	Range	Accuracy
1162-125AWL	0-125mm/0-5"	±0.05mm

- Measure thickness of disk brakes
- Resolution 0.01mm/0.0005"
- Buttons: on/off, zero, mm/inch
- Automatic power off, move the digital unit to turn on power
- Battery CR2032
- Made of stainless steel

DIGITAL DISK BRAKE AND PAD CALIPERS

- Measure thickness of disk brakes and pad wear
- Resolution: 0.01mm/0.0005"
- Buttons: on/off, zero, mm/inch
- Automatic power off, move the digital unit to turn on power
- Battery CR2032
- Made of stainless steel

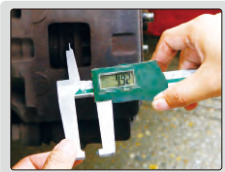

1167-150A

RELATIVE PRODUCT: DISK BRAKE MICROMETER (CODE 3288-, 3588-)

DATA OUTPUT

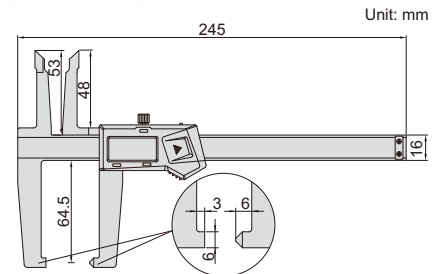

Unit: mm

With data interface (data output cable code 7315-21, 7302-21, optional)

Code	Range	Accuracy
1167-150A	0-150mm/0-6"	±0.07mm

Built-in wireless (receiver code 7315-2/3/6/7/8 is required)

Code	Range	Accuracy
1167-150AWL	0-150mm/0-6"	±0.07mm

RELATIVE PRODUCT: DISK BRAKE MICROMETER (CODE 3288-, 3588-)

DATA OUTPUT

- Measure internal and external diameter of drum brakes
- Resolution 0.01mm/0.0005"
- Buttons: on/off, zero, mm/inch
- Automatic power off, move the digital unit to turn on power
- Battery CR2032
- Made of stainless steel



1168-300A

DIGITAL DRUM BRAKE CALIPERS

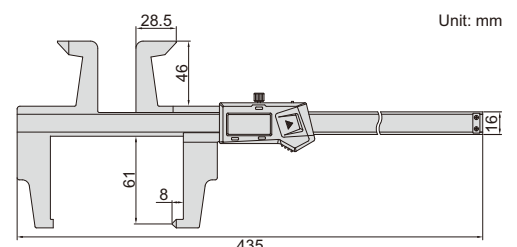

Unit: mm

With data interface (data output cable code 7315-21, 7302-21, optional)

Code	Range	Accuracy
1168-300A	0-300mm/0-12"	±0.07mm

Built-in wireless (receiver code 7315-2/3/6/7/8 is required)

Code	Range	Accuracy
1168-300AWL	0-300mm/0-12"	±0.07mm

DIGITAL DRUM BRAKE CALIPER

DATA OUTPUT

2

3

calibration block (included)

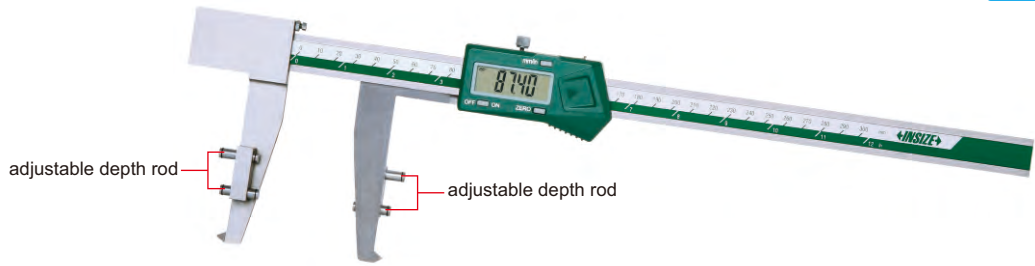

1538-300

- Measure internal diameter of drum brakes
- Resolution: 0.01mm/0.0005"
- Buttons: on/off, zero, mm/inch
- Automatic power off, move the digital unit to turn on power
- Battery CR2032
- Data output
- Made of stainless steel
- Optional accessory: data output cable (code 7315-22, 7302-22)

Code	Range	Accuracy
1538-300	30-300mm/1.2-12"	±0.05mm

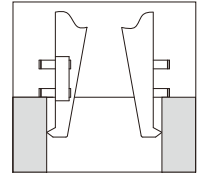
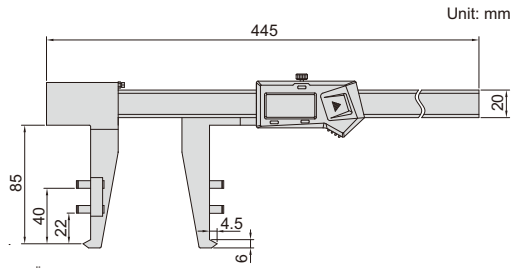

IP67 WATERPROOF DIGITAL DEPTH GAGES

IP67 WATERPROOF

ATTENTION: NO DATA OUTPUT

- IP67 dust/waterproof
- Resolution: 0.01mm/0.0005"
- Button function: zero, on/off, mm/inch, ABS/REL, hold
- Meet DIN862
- Battery CR2032
- Made of stainless steel



1149-150

ATTENTION: IT IS NECESSARY TO SET ZERO AFTER POWER ON EACH TIME

Code	Range	Accuracy	L	a	b	d
1149-150	0-150mm/0-6"	±0.03mm	240mm	6mm	16mm	100mm
1149-200	0-200mm/0-8"	±0.03mm	290mm	6mm	16mm	100mm
1149-300	0-300mm/0-12"	±0.03mm	390mm	6mm	16mm	150mm

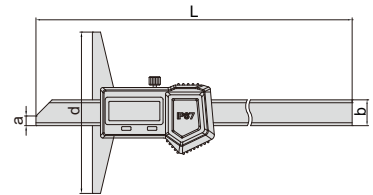

IP67 WATERPROOF DIGITAL DEPTH GAGES

ATTENTION: WHEN POWER ON 8 HOURS AFTER SHUTDOWN, IT IS NECESSARY TO SET ZERO

ATTENTION: NO DATA OUTPUT

IP67 WATERPROOF

- IP67 dust/waterproof
- Resolution: 0.01mm/0.0005"
- Large display
- Button function: zero, on/off, mm/inch
- Battery CR2032, automatic power off
- Meet DIN862
- Made of stainless steel



1541-150

Code	Range	Accuracy	L	a	d
1541-150	0-150mm/0-6"	±0.03mm	232.5mm	11mm	100mm
1541-200	0-200mm/0-8"	±0.03mm	285mm	11mm	100mm
1541-300	0-300mm/0-12"	±0.03mm	390mm	13.5mm	150mm

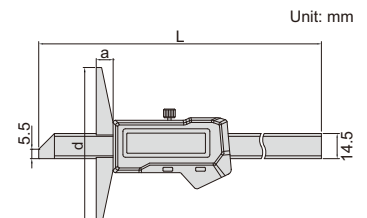

IP67
WATERPROOF

BLUETOOTH

BUILT-IN BLUETOOTH IP67 WATERPROOF DIGITAL DEPTH GAGES

ATTENTION: THE WORKING LIFE OF A BATTERY IS ABOUT 4-6 MONTHS

ATTENTION: WHEN POWER ON 8 HOURS AFTER SHUTDOWN, IT IS NECESSARY TO SET ZERO

- Built-in bluetooth 4.0 wireless transmission module, connect with computers (with bluetooth receiver), mobile phones, tablets, etc., and output keyboard signals
- Transmission distance is 10 meters (under the condition of no obstruction and no electromagnetic interference)
- IP67 dust/waterproof
- Resolution: 0.01mm/0.0005"
- Large display
- Button function: zero, on/off, mm/inch, data transmission
- Battery CR2032, automatic power off
- Meet DIN862
- Made of stainless steel



1542-150

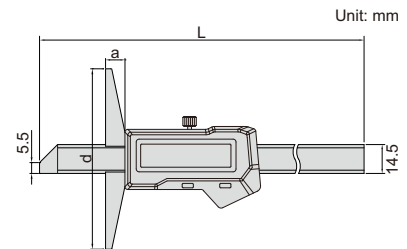

Code	Range	Accuracy	L	a	d
1542-150	0-150mm/0-6"	±0.03mm	232.5mm	11mm	100mm
1542-200	0-200mm/0-8"	±0.03mm	285mm	11mm	100mm
1542-300	0-300mm/0-12"	±0.03mm	390mm	13.5mm	150mm

DATA
OUTPUT

DIGITAL DEPTH GAGES (STANDARD TYPE)

- Buttons: on/off, zero, mm/inch
- Automatic power off, move the digital unit to turn on power
- Meet DIN862 (except 0-500mm/0-20", 0-1000mm/0-40", 0-1500mm/0-60")
- Battery CR2032
- Made of stainless steel



1141-150A

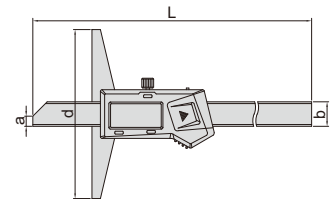

With data interface

Code	Range	Resolution	Accuracy	L	a	b	d	Data output cable (optional)
1141-150A	0-150mm/0-6"	0.01mm/0.0005"	±0.03mm	230mm	6mm	14.5mm	100mm	7315-21, 7302-21
1141-200A	0-200mm/0-8"	0.01mm/0.0005"	±0.03mm	280mm	6mm	14.5mm	100mm	7315-21, 7302-21
1141-300A	0-300mm/0-12"	0.01mm/0.0005"	±0.03mm	380mm	6mm	14.5mm	150mm	7315-21, 7302-21
1141-500A	0-500mm/0-20"	0.01mm/0.0005"	±0.05mm	585mm	7mm	15mm	150mm	7315-22, 7302-22
1141-5001A	0-500mm/0-20"	0.01mm/0.0005"	±0.05mm	585mm	7mm	15mm	200mm	7315-22, 7302-22
1141-1000A	0-1000mm/0-40"	0.01mm/0.0005"	±0.07mm	1188mm	7mm	18mm	150mm	7315-22, 7302-22
1141-10001A	0-1000mm/0-40"	0.01mm/0.0005"	±0.07mm	1188mm	7mm	18mm	200mm	7315-22, 7302-22
1141-10002A	0-1000mm/0-40"	0.01mm/0.0005"	±0.07mm	1188mm	7mm	18mm	250mm	7315-22, 7302-22
1141-10003A	0-1000mm/0-40"	0.01mm/0.0005"	±0.07mm	1188mm	7mm	18mm	300mm	7315-22, 7302-22
1141-1500A	0-1500mm/0-60"	0.01mm/0.0005"	±0.11mm	1695mm	7mm	18mm	200mm	7315-22, 7302-22

Built-in wireless (receiver code 7315-2/3/6/7/8 is required)

Code	Range	Resolution	Accuracy	L	a	b	d
1141-150AWL	0-150mm/0-6"	0.01mm/0.0005"	±0.03mm	230mm	6mm	14.5mm	100mm
1141-200AWL	0-200mm/0-8"	0.01mm/0.0005"	±0.03mm	280mm	6mm	14.5mm	100mm
1141-300AWL	0-300mm/0-12"	0.01mm/0.0005"	±0.03mm	380mm	6mm	14.5mm	150mm
1141-500AWL	0-500mm/0-20"	0.01mm/0.0005"	±0.05mm	585mm	7mm	15mm	150mm
1141-5001AWL	0-500mm/0-20"	0.01mm/0.0005"	±0.05mm	585mm	7mm	15mm	200mm

DIGITAL DEPTH GAGES WITH MOUNTING HOLES FOR EXTENSION BASE

DATA OUTPUT



1147-300

- Resolution: 0.01mm/0.0005"
- Buttons: on/off, zero, mm/inch
- Automatic power off, move the digital unit to turn on power
- Meet DIN862
- Battery CR2032
- Made of stainless steel
- Optional accessory: extension base (code 6141)

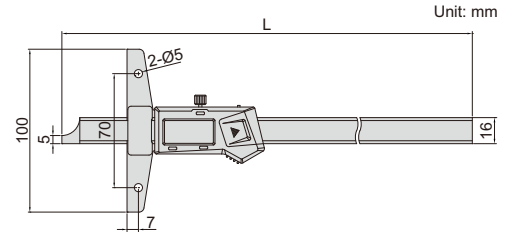

With data interface (data output cable code 7315-21, 7302-21, optional)

Code	Range	Accuracy	L
1147-150	0-150mm/0-6"	±0.03mm	237mm
1147-200	0-200mm/0-8"	±0.03mm	287mm
1147-300	0-300mm/0-12"	±0.03mm	403mm
1147-500	0-500mm/0-20"	±0.05mm	605mm

Built-in wireless (receiver code 7315-2/3/6/7/8 is required)

Code	Range	Accuracy	L
1147-150WL	0-150mm/0-6"	±0.03mm	237mm
1147-200WL	0-200mm/0-8"	±0.03mm	287mm
1147-300WL	0-300mm/0-12"	±0.03mm	403mm
1147-500WL	0-500mm/0-20"	±0.05mm	605mm

DIGITAL HOOK DEPTH GAGES

DATA OUTPUT

- Resolution: 0.01mm/0.0005"
- Buttons: on/off, zero, mm/inch
- Automatic power off, move the digital unit to turn on power
- Battery CR2032
- Made of stainless steel

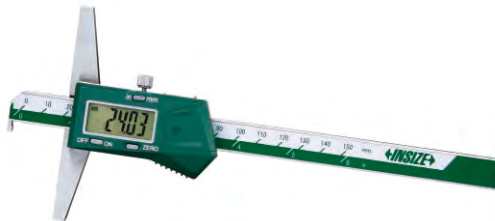

1142-150A

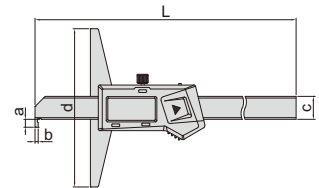

With data interface

Code	Range	Accuracy	L	d	a	b	c	Data output cable (optional)
1142-150A	0-150mm/0-6"	±0.03mm	230mm	100mm	5mm	2mm	14.5mm	7315-21, 7302-21
1142-200A	0-200mm/0-8"	±0.03mm	280mm	100mm	5mm	2mm	14.5mm	7315-21, 7302-21
1142-300A	0-300mm/0-12"	±0.04mm	380mm	150mm	5mm	2mm	14.5mm	7315-21, 7302-21
1142-500A	0-500mm/0-20"	±0.05mm	585mm	150mm	8mm	3mm	15mm	7315-22, 7302-22
1142-5001A	0-500mm/0-20"	±0.05mm	585mm	200mm	8mm	3mm	15mm	7315-22, 7302-22
1142-1000A	0-1000mm/0-40"	±0.07mm	1188mm	150mm	10mm	4mm	18mm	7315-22, 7302-22
1142-10001A	0-1000mm/0-40"	±0.07mm	1188mm	200mm	10mm	4mm	18mm	7315-22, 7302-22
1142-10002A	0-1000mm/0-40"	±0.07mm	1188mm	250mm	10mm	4mm	18mm	7315-22, 7302-22

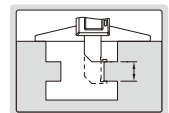
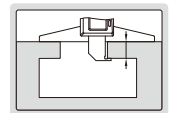
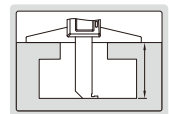

Built-in wireless (receiver code 7315-2/3/6/7/8 is required)

Code	Range	Accuracy	L	d	a	b	c
1142-150AWL	0-150mm/0-6"	±0.03mm	230mm	100mm	5mm	2mm	14.5mm
1142-200AWL	0-200mm/0-8"	±0.03mm	280mm	100mm	5mm	2mm	14.5mm
1142-300AWL	0-300mm/0-12"	±0.04mm	380mm	150mm	5mm	2mm	14.5mm
1142-500AWL	0-500mm/0-20"	±0.05mm	585mm	150mm	8mm	3mm	15mm
1142-5001AWL	0-500mm/0-20"	±0.05mm	585mm	200mm	8mm	3mm	15mm

DATA
OUTPUT

DIGITAL DOUBLE HOOK DEPTH GAGES

3



1144-150A

- Resolution: 0.01mm/0.0005"
- Buttons: on/off, zero, mm/inch
- Automatic power off, move the digital unit to turn on power
- Meet DIN862
- Battery CR2032
- Made of stainless steel

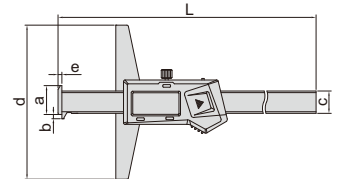
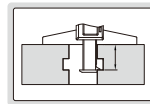
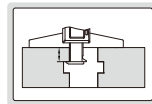

With data interface

Code	Range	Accuracy	L	d	a	b	c	e	Data output cable (optional)
1144-150A	0-150mm/0-6"	±0.03mm	233mm	100mm	21.5mm	3.5mm	14.5mm	2.5mm	7315-21, 7302-21
1144-200A	0-200mm/0-8"	±0.03mm	283mm	100mm	21.5mm	3.5mm	14.5mm	2.5mm	7315-21, 7302-21
1144-300A	0-300mm/0-12"	±0.03mm	383mm	150mm	21.5mm	3.5mm	14.5mm	2.5mm	7315-21, 7302-21
1144-500A	0-500mm/0-20"	±0.05mm	585mm	150mm	25mm	5mm	15mm	3mm	7315-22, 7302-22
1144-5001A	0-500mm/0-20"	±0.05mm	585mm	200mm	25mm	5mm	15mm	3mm	7315-22, 7302-22
1144-1000A	0-1000mm/0-40"	±0.07mm	1188mm	150mm	32mm	7mm	18mm	4mm	7315-22, 7302-22
1144-10001A	0-1000mm/0-40"	±0.07mm	1188mm	200mm	32mm	7mm	18mm	4mm	7315-22, 7302-22
1144-10002A	0-1000mm/0-40"	±0.07mm	1188mm	250mm	32mm	7mm	18mm	4mm	7315-22, 7302-22

Built-in wireless (receiver code 7315-2/3/6/7/8 is required)

Code	Range	Accuracy	L	d	a	b	c	e
1144-150AWL	0-150mm/0-6"	±0.03mm	233mm	100mm	21.5mm	3.5mm	14.5mm	2.5mm
1144-200AWL	0-200mm/0-8"	±0.03mm	283mm	100mm	21.5mm	3.5mm	14.5mm	2.5mm
1144-300AWL	0-300mm/0-12"	±0.03mm	383mm	150mm	21.5mm	3.5mm	14.5mm	2.5mm
1144-500AWL	0-500mm/0-20"	±0.05mm	585mm	150mm	25mm	5mm	15mm	3mm
1144-5001AWL	0-500mm/0-20"	±0.05mm	585mm	200mm	25mm	5mm	15mm	3mm

DATA
OUTPUT

DIGITAL POINT DEPTH GAGES



1143-200A

- Resolution: 0.01mm/0.0005"
- Buttons: on/off, zero, mm/inch
- Automatic power off, move the digital unit to turn on power
- Meet DIN862
- Battery CR2032
- Made of stainless steel

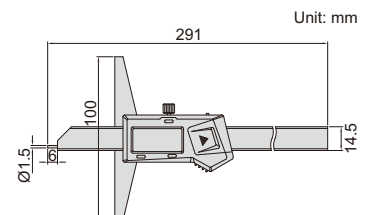
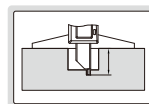

With data interface (data output cable code 7315-21, 7302-21, optional)

Code	Range	Accuracy
1143-200A	0-200mm/0-8"	±0.03mm

Built-in wireless (receiver code 7315-2/3/6/7/8 is required)

Code	Range	Accuracy
1143-200AWL	0-200mm/0-8"	±0.03mm

DIGITAL DEPTH GAGES WITH ROUND DEPTH BAR

MEASURE WIDTH AND DEPTH OF GROOVES INSIDE BORE

MEASURE DEPTH OF SMALL HOLES (>Ø4mm)

DATA OUTPUT

3

- Resolution: 0.01mm/0.0005"
- Supplied with three interchangeable points (flat, spherical, disk)
- Buttons: on/off, set, mm/inch, preset (+, -)
- Automatic power off, move the digital unit to turn on power
- Battery CR2032
- Made of stainless steel
- Optional accessory: extension base (code 6141, for 1148-120, 1148-120WL, 1148-200, 1148-200WL, 1148-300 and 1148-300WL)

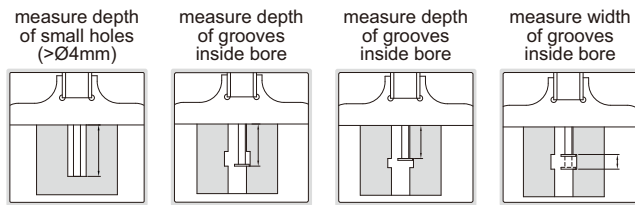
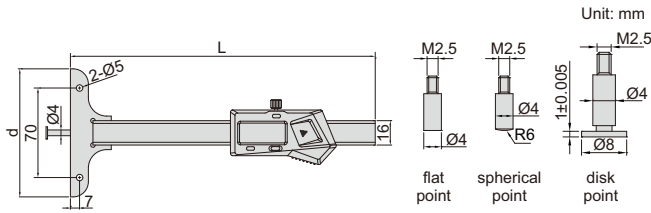

1148-100S



1148-120



1148-200



With data interface (data output cable code 7315-21, 7302-21, optional)

Code	Range *	Accuracy	L	d	Remark
1148-100S	0-100mm/0-4"	±0.02mm	200mm	45mm	
1148-100	0-100mm/0-4"	±0.02mm	200mm	85mm	
1148-120	0-120mm/0-4.7"	±0.03mm	300mm	101mm	one-hand use, with mounting holes for extension base
1148-200	0-200mm/0-8"	±0.03mm	300mm	101mm	with mounting holes for extension base
1148-300	0-300mm/0-12"	±0.04mm	400mm	101mm	with mounting holes for extension base

one-hand use of 1148-120 and 1148-120WL



extension base for 1148-120, 1148-120WL, 1148-200, 1148-200WL, 1148-300 and 1148-300WL (optional)



Built-in wireless (receiver code 7315-2/3/6/7/8 is required)

Code	Range *	Accuracy	L	d	Remark
1148-100SWL	0-100mm/0-4"	±0.02mm	200mm	45mm	
1148-100WL	0-100mm/0-4"	±0.02mm	200mm	85mm	
1148-120WL	0-120mm/0-4.7"	±0.03mm	300mm	101mm	one-hand use, with mounting holes for extension base
1148-200WL	0-200mm/0-8"	±0.03mm	300mm	101mm	with mounting holes for extension base
1148-300WL	0-300mm/0-12"	±0.04mm	400mm	101mm	with mounting holes for extension base

1148-P103 (optional), measure width of bottom grooves inside blind hole

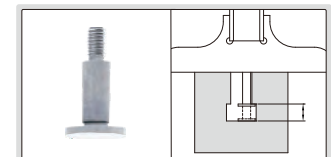

*When disk points are used, the range is reduced by 10mm

OPTIONAL DISK POINTS

Code	Description	H	Remark
1148-P101	0.5mm disk point	0.5±0.005mm	for narrow grooves
1148-P102	0.7mm disk point	0.7±0.005mm	for narrow grooves
1148-P103	1mm disk point	1±0.005mm	for grooves inside blind hole
1148-P104	0.5mm disk point	0.5±0.005mm	for grooves inside blind hole

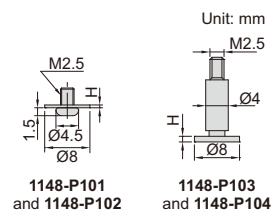

DATA OUTPUT

- Resolution: 0.01mm/0.0005"
- Buttons: on/off, zero, mm/inch, ABS/INC, data hold, TOL, set
- ABS/INC is for absolute and incremental measurement
- TOL is for tolerance measurement
- Made of stainless steel
- LR44 battery, data output
- Supplied with gage block for zero setting
- Optional accessory: extension base, wireless transmitter (code **7315-1150**), data output cable (code **7302-SPC7**, keyboard format)

Extension base

Code	L
1540-L300	300mm
1540-L400	400mm
1540-L500	500mm
1540-L600	600mm
1540-L800	800mm

gage block for zero setting (included)



Code	Range	Accuracy
1540-300	0-300mm/0-12"	±0.04mm

DIGITAL DOUBLE HOOK DEPTH GAGE

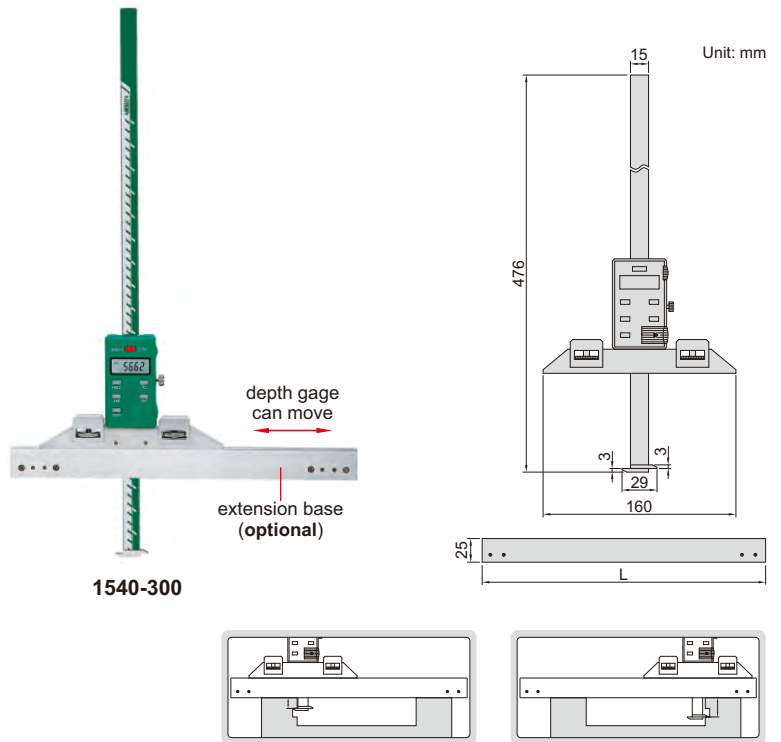

SHOCK PROOF

- Shockproof dial indicator
- Made of stainless steel

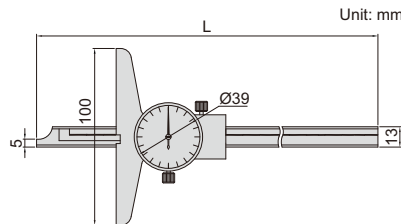

DIAL DEPTH GAGES



1340-150

Code	Range	Graduation	Accuracy	L
1340-150	0-150mm	0.02mm	±0.03mm	232mm
1340-200	0-200mm	0.02mm	±0.03mm	282mm
1340-300	0-300mm	0.02mm	±0.04mm	382mm

VERNIER DEPTH GAGES (STANDARD TYPE)

- Made of stainless steel
- Satin chrome plated reading surface

Graduation 0.05mm

Code	Range	Accuracy	L	d
1240-150	0-150mm	±0.05mm	245mm	100mm
1240-200	0-200mm	±0.05mm	282mm	100mm
1240-300	0-300mm	±0.08mm	382mm	100mm
1240-500	0-500mm	±0.09mm	585mm	150mm



1240-2001

Graduation 0.02mm

Code	Range	Accuracy	L	d
1240-1501	0-150mm	±0.03mm	245mm	100mm
1240-2001	0-200mm	±0.03mm	282mm	100mm
1240-3001	0-300mm	±0.04mm	382mm	100mm
1240-5001	0-500mm	±0.05mm	585mm	150mm

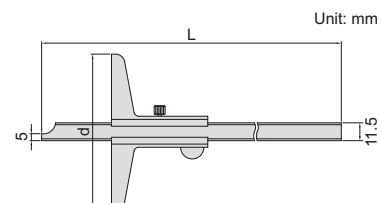

VERNIER DEPTH GAGES

WITH MOUNTING HOLES FOR EXTENSION BASE

extension base (optional)



- Made of stainless steel
- Satin chrome plating finish on reading surface
- Optional accessory: extension base (code 6141)

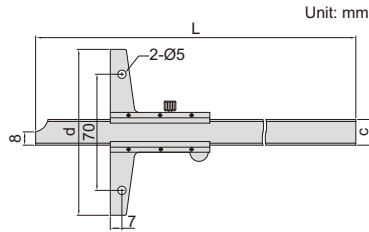

1247-2001

Graduation 0.05mm

Code	Range	Accuracy
1247-150	0-150mm	±0.05mm
1247-200	0-200mm	±0.05mm
1247-300	0-300mm	±0.08mm
1247-600	0-600mm	±0.10mm
1247-1000	0-1000mm	±0.15mm

Graduation 0.02mm

Code	Range	Accuracy
1247-1501	0-150mm	±0.03mm
1247-2001	0-200mm	±0.03mm
1247-3001	0-300mm	±0.04mm
1247-6001	0-600mm	±0.05mm
1247-1001	0-1000mm	±0.07mm

Range	L	c	d
0-150mm	240mm	16mm	100mm
0-200mm	290mm	16mm	100mm
0-300mm	390mm	16mm	100mm
0-600mm	704mm	16mm	150mm
0-1000mm	1124mm	16mm	200mm

VERNIER DEPTH GAGES WITH FINE ADJUSTMENT

WITH MOUNTING HOLES FOR EXTENSION BASE

- With fine adjustment
- Made of stainless steel
- Satin chrome plating finish on reading surface
- Optional accessory: extension base (code 6141)

Graduation 0.05mm

Code	Range	Accuracy
1249-150	0-150mm	±0.05mm
1249-200	0-200mm	±0.05mm
1249-300	0-300mm	±0.08mm

Graduation 0.02mm

Code	Range	Accuracy
1249-1501	0-150mm	±0.03mm
1249-2001	0-200mm	±0.03mm
1249-3001	0-300mm	±0.04mm

Range	L	c	d
0-150mm	256mm	16mm	100mm
0-200mm	306mm	16mm	100mm
0-300mm	406mm	16mm	100mm

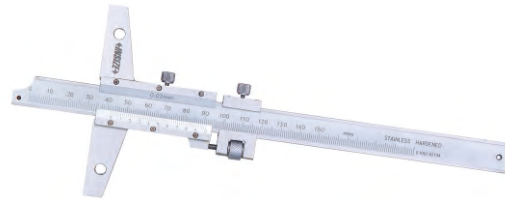

1249-1501

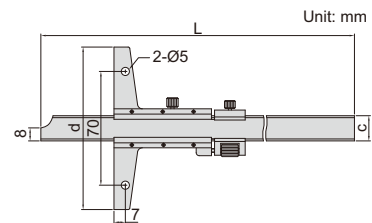

VERNIER HOOK DEPTH GAGES

WITH MOUNTING HOLES FOR EXTENSION BASE

- Made of stainless steel
- Satin chrome plating finish on reading surface
- Optional accessory: extension base (code 6141)

Graduation 0.05mm

Code	Range	Accuracy	L
1248-150	0-150mm	±0.05mm	266mm
1248-200	0-200mm	±0.05mm	316mm
1248-300	0-300mm	±0.08mm	416mm

Graduation 0.02mm

Code	Range	Accuracy	L
1248-1501	0-150mm	±0.03mm	266mm
1248-2001	0-200mm	±0.03mm	316mm
1248-3001	0-300mm	±0.04mm	416mm

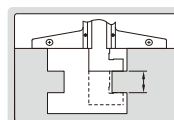
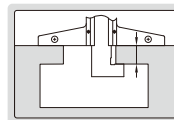
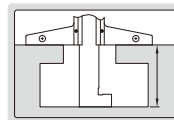

1248-1501

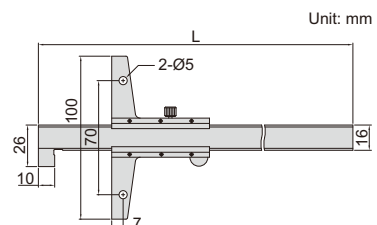

VERNIER HOOK DEPTH GAGE

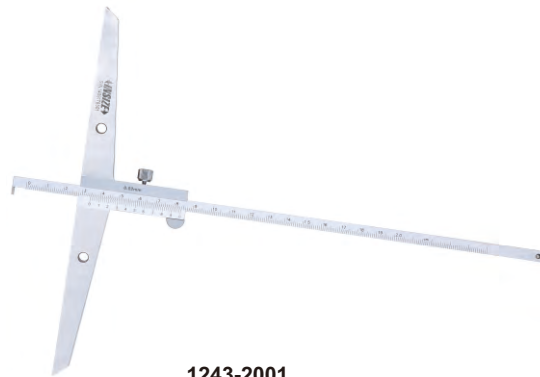

1243-2001

- Graduation 0.02mm
- Made of stainless steel
- Satin chrome plating finish on reading surface
- Optional accessory: extension base (code 6141)

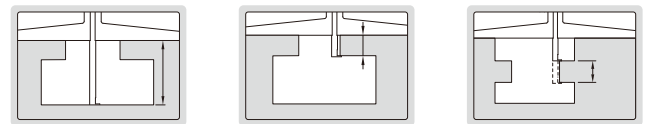
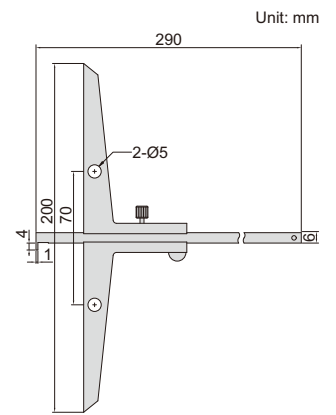

Code	Range	Accuracy
1243-2001	0-200mm	±0.04mm

EXTENSION BASES



6141-260

- Supplied with two screws
- Made of stainless steel
- Suitable for depth gages series 1147, 1148, 1243, 1247, 1248 and 1249

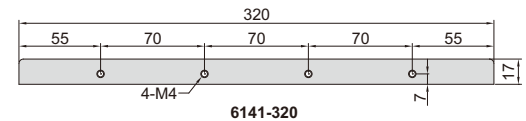
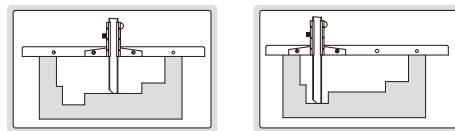
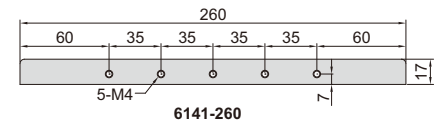
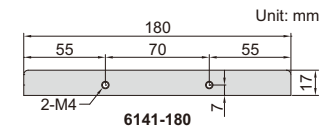

Code	Length
6141-180	180mm
6141-260	260mm
6141-320	320mm
6141-600	600mm

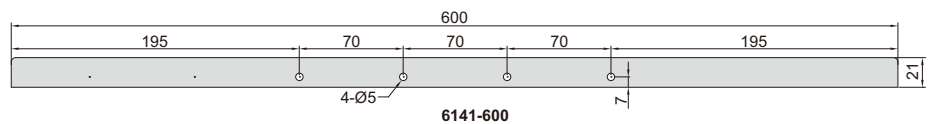

VERNIER DEPTH GAGE (ECONOMIC TYPE)

- Graduation: 0.1mm
- Made of stainless steel



1244-30

Unit: mm

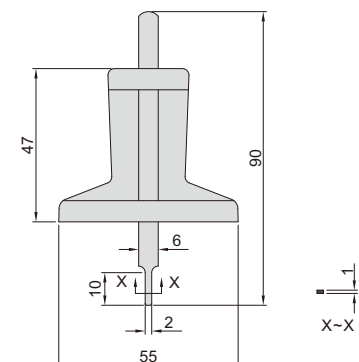

Code	Range	Accuracy
1244-30	0-30mm	±0.10mm

MINI DIGITAL DEPTH GAGES WITH ROUND BAR

DATA OUTPUT

3

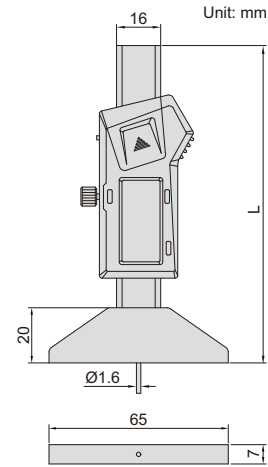

1140-25

- Measure depth of small groove and hole
- Resolution: 0.01mm/0.0005"
- Buttons: on/off, set, mm/inch, preset (+,-)
- Automatic power off, move the digital unit to turn on power
- Battery CR2032
- Made of stainless steel

With data interface (data output cable code 7315-21, 7302-21, optional)

Code	Range	Accuracy	L
1140-25	0-25mm/0-1"	±0.02mm	114mm
1140-50	0-50mm/0-2"	±0.02mm	140mm

Built-in wireless (receiver code 7315-2/3/6/7/8 is required)

Code	Range	Accuracy	L
1140-25WL	0-25mm/0-1"	±0.02mm	114mm
1140-50WL	0-50mm/0-2"	±0.02mm	140mm

MINI DIGITAL DEPTH GAGES

DATA OUTPUT

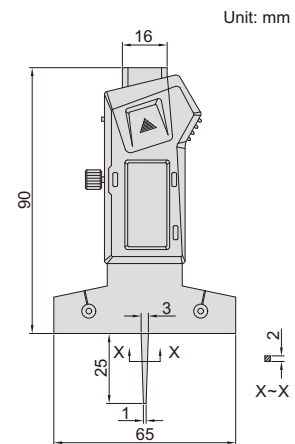

1145-25A

- Measure depth of small groove and hole, also measure depth of tire tread
- Resolution: 0.01mm/0.0005"
- Buttons: on/off, zero, mm/inch
- Supplied with zero set surface
- Automatic power off, move the digital unit to turn on power
- Battery CR2032
- Made of stainless steel

With data interface (data output cable code 7315-21, 7302-21, optional)

Code	Range	Accuracy
1145-25A	0-25mm/0-1"	±0.03mm

Built-in wireless (receiver code 7315-2/3/6/7/8 is required)

Code	Range	Accuracy
1145-25AWL	0-25mm/0-1"	±0.03mm

DIAL DEPTH GAGES

Unit: mm

- Accuracy: $\pm 0.017\text{mm}$
- Stainless steel base
- Pointed tip



2343-102

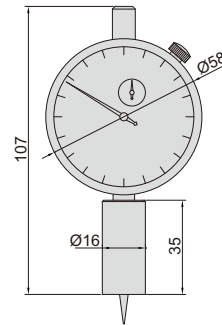

2343-101

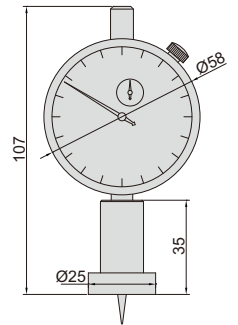

2343-102

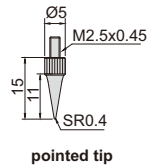

pointed tip

Code	Range	Dial indicator stroke	Dial indicator graduation	Base
2343-101	0-10mm	10mm	0.01mm	$\varnothing 16\text{mm}$
2343-102	0-10mm	10mm	0.01mm	$\varnothing 25\text{mm}$

DATA OUTPUT

DIGITAL DEPTH GAGES

Unit: mm

- Button function: on/off, zero, mm/inch, ABS, data preset, change measuring direction
- CR2032 battery, automatic power off (time is adjustable)
- Data output
- Stainless steel base
- Pointed tip
- Optional accessory: data output cable (code 7315-50M, 7302-40M)



2142-102

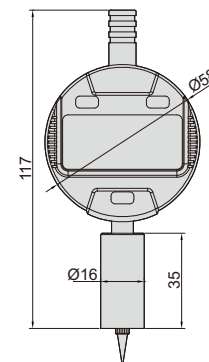

2142-101/2142-301

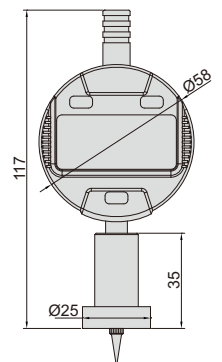

2142-102/2142-302

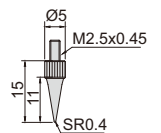

pointed tip

Code	Range	Digital indicator stroke	Digital indicator resolution	Accuracy	Base
2142-101	0-12.7mm/0-0.5"	12.7mm/0.5"	0.01mm/0.0005"	$\pm 20\mu\text{m}$	$\varnothing 16\text{mm}$
2142-102	0-12.7mm/0-0.5"	12.7mm/0.5"	0.01mm/0.0005"	$\pm 20\mu\text{m}$	$\varnothing 25\text{mm}$
2142-301	0-12.7mm/0-0.5"	12.7mm/0.5"	0.001mm/0.00005"	$\pm 5\mu\text{m}$	$\varnothing 16\text{mm}$
2142-302	0-12.7mm/0-0.5"	12.7mm/0.5"	0.001mm/0.00005"	$\pm 5\mu\text{m}$	$\varnothing 25\text{mm}$

DIAL DEPTH GAGE

- Accuracy: $\pm 0.017\text{mm}$
- Stainless steel base
- Supplied with pointed tip and ball tip



2341-101A

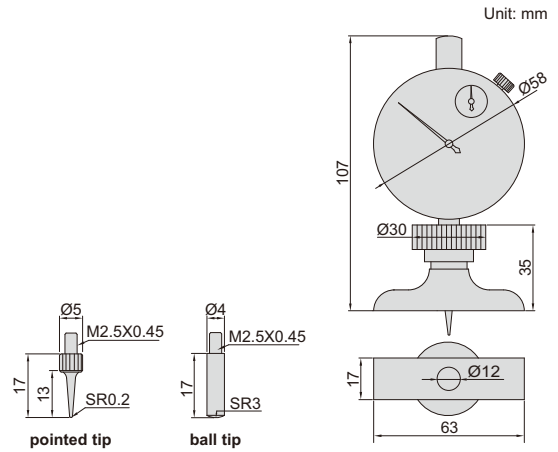

Code	Range	Dial indicator stroke	Dial indicator graduation
2341-101A	0-10mm	10mm	0.01mm

DIAL DEPTH GAGES



2342-202

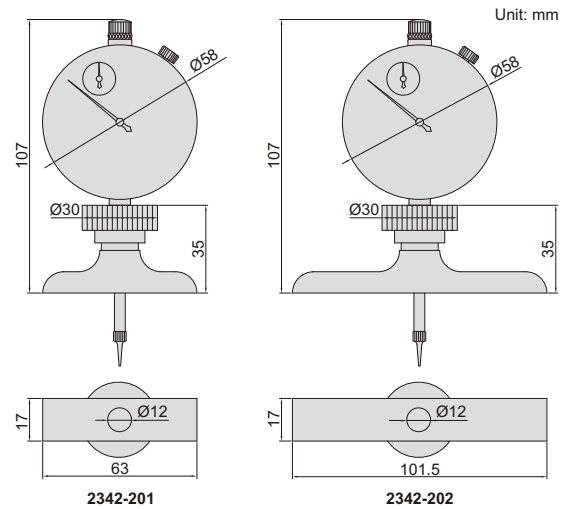

2141-10 (optional), can be customized according to workpieces

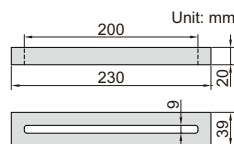

- Dial indicator graduation: 0.01mm
- Accuracy: $\pm 0.03\text{mm}$
- Stainless steel base
- Extension rods: 25mm (1 pc), 50mm (1 pc), 75mm (1 pc), 100mm (2 pcs)
- Supplied with pointed tip and ball tip
- Optional accessory: granite extension holder (code 2141-10)

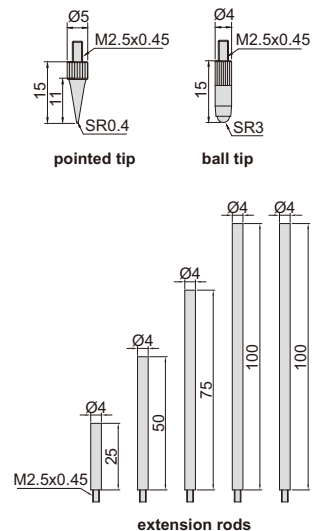
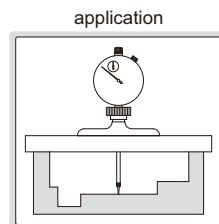

Code	Range	Dial indicator stroke	Base
2342-201	0-300mm	30mm	63x17mm
2342-202	0-300mm	30mm	101.5x17mm

DATA
OUTPUT

DIGITAL DEPTH GAGES

3



2141-202A

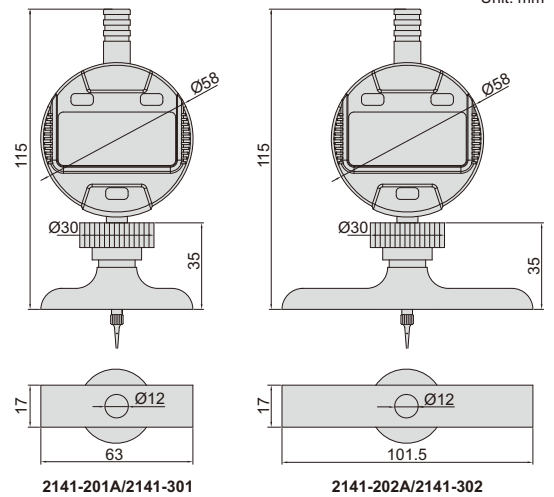

Unit: mm

2141-201A/2141-301

2141-202A/2141-302

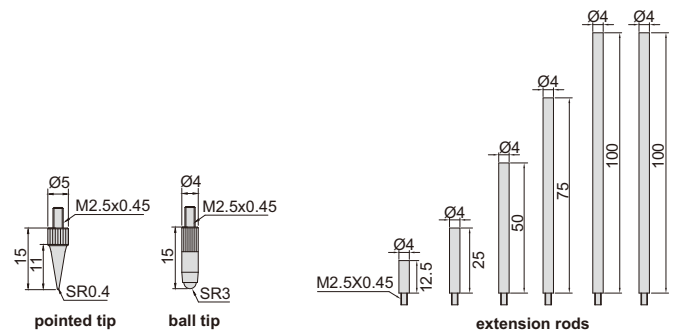

pointed tip

ball tip

extension rods



2141-10 (optional),
can be customized
according to workpieces

application

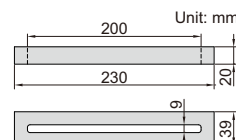
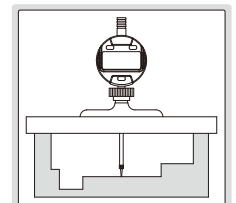

- Button function: on/off, zero, mm/inch, ABS, data preset, change measuring direction
- CR2032 battery, automatic power off (time is adjustable)
- Data output
- Stainless steel base
- Extension rods: 12.5mm (1 pc), 25mm (1 pc), 50mm (1 pc), 75mm (1 pc), 100mm (2 pcs)
- Supplied with pointed tip and ball tip
- Optional accessory: data output cable (code 7315-50M, 7302-40M), granite extension holder (code 2141-10)

Code	Range	Digital indicator stroke	Digital indicator resolution	Accuracy	Base
2141-201A	0-300mm/0-12"	12.7mm/0.5"	0.01mm/0.0005"	±20µm	63x17mm
2141-202A	0-300mm/0-12"	12.7mm/0.5"	0.01mm/0.0005"	±20µm	101.5x17mm
2141-301	0-300mm/0-12"	12.7mm/0.5"	0.001mm/0.00005"	±5µm	63x17mm
2141-302	0-300mm/0-12"	12.7mm/0.5"	0.001mm/0.00005"	±5µm	101.5x17mm

DIGITAL GROOVE GAGES

DATA OUTPUT



2145-202

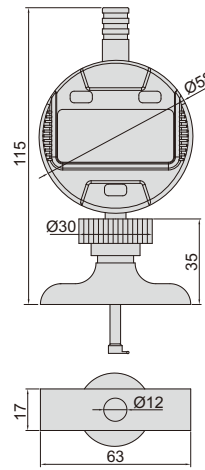

2145-201/2145-301

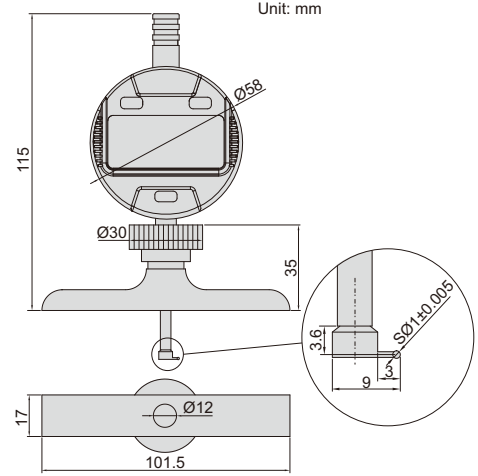

2145-202/2145-302

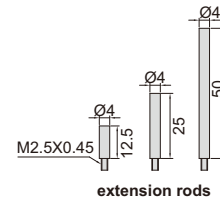

extension rods

- Button function: on/off, zero, mm/inch, absolute/incremental measurement, data preset, measuring direction change
- CR2032 battery, automatic power off (time is adjustable)
- Data output
- Stainless steel base
- Supplied with extension rods: 12.5mm (1 pc), 25mm (1 pc), 50mm (1 pc)
- Supplied with groove point
- Optional accessory: data output cable (code 7315-50M, 7302-40M, 7305-40M)

measure width (b) and depth (a) of groove

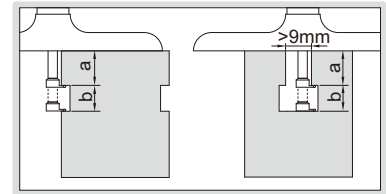

Code	Range (a)	Digital indicator stroke (b)	Digital indicator resolution	Accuracy	Base
2145-201	0-85mm/0-3.35"	12.7mm/0.5"	0.01mm/0.0005"	±20µm	63x17mm
2145-202	0-85mm/0-3.35"	12.7mm/0.5"	0.01mm/0.0005"	±20µm	101.5x17mm
2145-301	0-85mm/0-3.35"	12.7mm/0.5"	0.001mm/0.00005"	±5µm	63x17mm
2145-302	0-85mm/0-3.35"	12.7mm/0.5"	0.001mm/0.00005"	±5µm	101.5x17mm

DIGITAL DEPTH GAGE (60° KNIFE EDGE BASE)

DATA OUTPUT

- Button function: on/off, zero, inch/mm, ABS, data preset, change measuring direction
- CR2032 battery, automatic power off (time is adjustable)
- Data output
- Stainless steel base with 60° knife edge
- Optional accessory: data output cable (code 7315-50M, 7302-40M)



front view

side view

2143-101

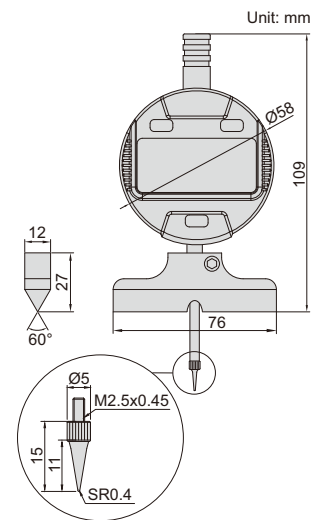

Code	Range	Digital indicator stroke	Digital indicator resolution	Accuracy
2143-101	0-12.7mm/0-0.5"	12.7mm/0.5"	0.01mm/0.0005"	±20µm

IP65
WATERPROOF

DATA
OUTPUT

DIGITAL DEPTH MICROMETERS

3

- Resolution: 0.001mm/0.00005"
- Micrometer head accuracy: $\pm 3\mu\text{m}$
- Rod accuracy: $\pm (2+L/75)\mu\text{m}$, L is the measuring range in mm
- Button function: on/off, set, mm/inch, ABS/INC
- IP65 dust/waterproof
- Data output
- Automatic power off
- Rods with flat end
- Ratchet stop
- Optional accessory: data output cable (code 7315-30, 7302-30)

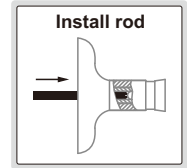

3540-50

Code	Range	Rods	L
3540-25	0-25mm/0-1"	1 pc	101.5mm
3540-50	0-50mm/0-2"	2 pcs	101.5mm
3540-100	0-100mm/0-4"	4 pcs	101.5mm
3540-150	0-150mm/0-6"	6 pcs	101.5mm
3540-300	0-300mm/0-12"	12 pcs	101.5mm
3540-B25	0-25mm/0-1"	1 pc	63mm
3540-B50	0-50mm/0-2"	2 pcs	63mm
3540-B100	0-100mm/0-4"	4 pcs	63mm
3540-B150	0-150mm/0-6"	6 pcs	63mm
3540-B300	0-300mm/0-12"	12 pcs	63mm

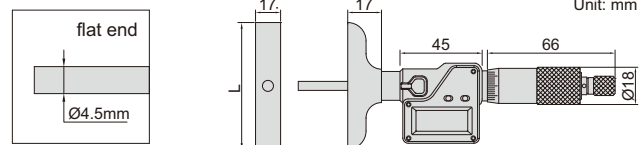

DEPTH MICROMETERS

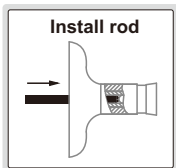

- Meet DIN863-2
- Graduation: 0.01mm
- Micrometer head accuracy: $\pm 3\mu\text{m}$
- Rod accuracy: $\pm (2+L/75)\mu\text{m}$, L is the measuring range in mm
- Rods with flat or spherical end
- Ratchet stop



3240-100

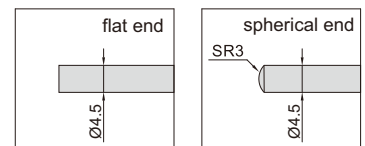
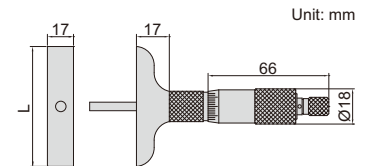

Flat end

Code	Range	Rods	L
3240-25	0-25mm	1 pc	101.5mm
3240-50	0-50mm	2 pcs	101.5mm
3240-75	0-75mm	3 pcs	101.5mm
3240-100	0-100mm	4 pcs	101.5mm
3240-150	0-150mm	6 pcs	101.5mm
3240-200	0-200mm	8 pcs	101.5mm
3240-300	0-300mm	12 pcs	101.5mm
3240-B25	0-25mm	1 pc	63mm
3240-B50	0-50mm	2 pcs	63mm
3240-B100	0-100mm	4 pcs	63mm
3240-B150	0-150mm	6 pcs	63mm
3240-B300	0-300mm	12 pcs	63mm

Spherical end

Code	Range	Rods	L
3240-25S	0-25mm	1 pc	101.5mm
3240-50S	0-50mm	2 pcs	101.5mm
3240-100S	0-100mm	4 pcs	101.5mm
3240-150S	0-150mm	6 pcs	101.5mm
3240-300S	0-300mm	12 pcs	101.5mm
3240-B25S	0-25mm	1 pc	63mm
3240-B50S	0-50mm	2 pcs	63mm
3240-B100S	0-100mm	4 pcs	63mm
3240-B150S	0-150mm	6 pcs	63mm
3240-B300S	0-300mm	12 pcs	63mm

DEPTH MICROMETERS

3

4

- Meet DIN863-2
- Graduation: 0.01mm
- Micrometer head accuracy: $\pm 3\mu\text{m}$
- Rod accuracy: $\pm (2+L/75)\mu\text{m}$, L is the measuring range in mm
- Rods with flat end
- Ratchet stop



Code	Range	Rods	L
3241-25	0-25mm	1 pc	101.5mm
3241-50	0-50mm	2 pcs	101.5mm
3241-75	0-75mm	3 pcs	101.5mm
3241-100	0-100mm	4 pcs	101.5mm
3241-150	0-150mm	6 pcs	101.5mm
3241-200	0-200mm	8 pcs	101.5mm
3241-300	0-300mm	12 pcs	101.5mm
3241-B25	0-25mm	1 pc	63mm
3241-B50	0-50mm	2 pcs	63mm
3241-B100	0-100mm	4 pcs	63mm
3241-B150	0-150mm	6 pcs	63mm
3241-B300	0-300mm	12 pcs	63mm

3241-100

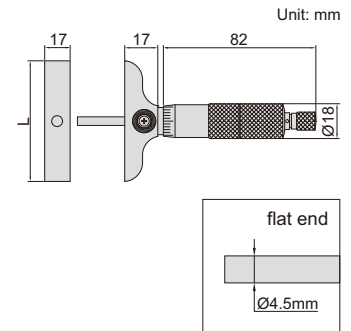
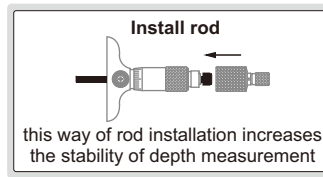

HIGH PRECISION DIGITAL HEIGHT GAGES



power supplied by charge pal

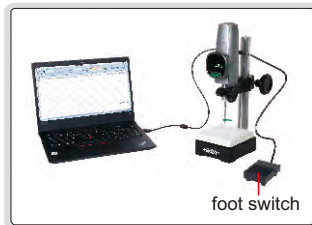

data transmitted to Excel without software; short press the foot switch to transmit data, long press to zero

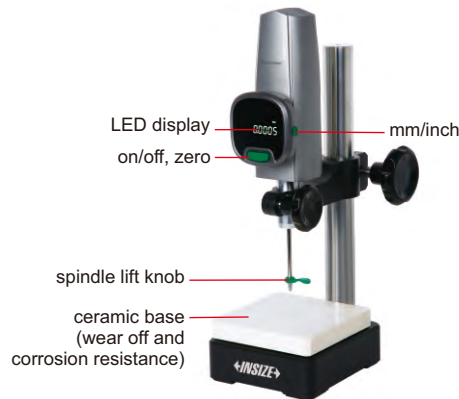

1155-505

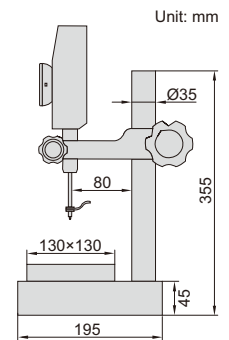

- High stability, high precision, high response speed (5000mm/s)
- High brightness LED display
- Ceramic base flatness: $1\mu\text{m}$

Code	Range	Resolution	Accuracy (20°C)	Measuring force	Output	Power supply
1155-505	0~50mm	0.5 μm /0.00002" (can switch to: 1 μm /0.00005")	1.5 μm	0.8~1.2N	USB	5V/1A (adapter or charge pal)
1155-510	0~50mm	0.1 μm /0.000005" (can switch to: 1 μm /0.00005")	1 μm	0.8~1.2N	USB	5V/1A (adapter or charge pal)

OPTIONAL ACCESSORY

Contact point	code 6282
Charge pal	1155-5-POB
Data output cables (including foot switch)	1155-5-FOS

STANDARD DELIVERY

Main unit	1 pc
-----------	------

DIGITAL HEIGHT GAGES

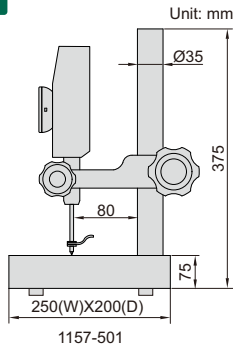

1157-501

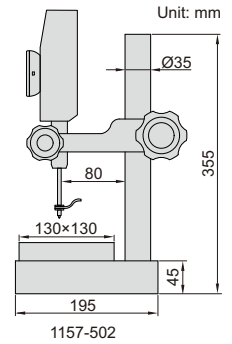
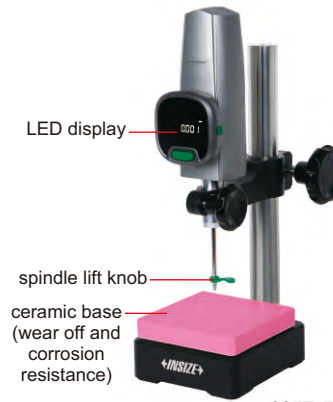

1157-502

- Buttons: on/off, zero, mm/inch, mix/min/mix-min
- High response speed (5000mm/s)
- High brightness LED display



power supplied by charge pal



foot switch

data transmitted to Excel without software; short press the foot switch to transmit data, long press to zero

Code	Range	Resolution	Accuracy (20°C)	Measuring force	Output	Power supply	Base
1157-501	0~50mm	1µm/0.00005"	3µm	0.8~1.2N	USB	5V/1A (adapter or charge pal)	granite (flatness: 2µm)
1157-502	0~50mm	1µm/0.00005"	3µm	0.8~1.2N	USB	5V/1A (adapter or charge pal)	ceramic (flatness: 1µm)

OPTIONAL ACCESSORY

Contact point	code 6282
Charge pal	1155-5-POB
Data output cables (including foot switch)	1155-5-FOS

STANDARD DELIVERY

Main unit	1 pc
-----------	------

LARGE RANGE DIGITAL HEIGHT GAGE

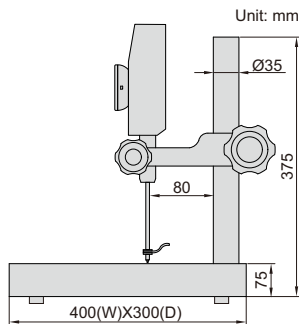

- High stability, high precision, high response speed (5000mm/s)
- High brightness LED display
- Granite base flatness: 3µm

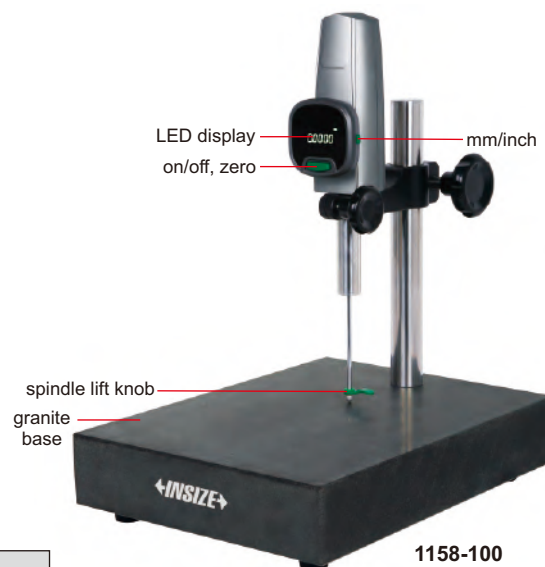

1158-100



power supplied by charge pal

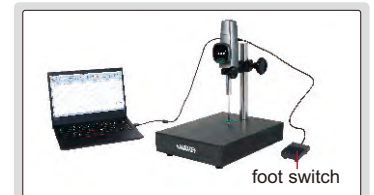

foot switch

data transmitted to Excel without software; short press the foot switch to transmit data, long press to zero

STANDARD DELIVERY

Main unit	1 pc
-----------	------

OPTIONAL ACCESSORY

Contact point	code 6282
Charge pal	1155-5-POB
Data output cables (including foot switch)	1155-5-FOS

Code	Range	Resolution	Accuracy (20°C)	Measuring force	Output	Power supply
1158-100	0~100mm	0.1µm/0.000005" (can switch to: 1µm/0.00005")	3µm	0.8~1.2N	USB	5V/1A (adapter or charge pal)