

Specification: **ASME B1.2**

UNC - Unified National Coarse

Application: General purpose fastening.

Imperial system of units (Inch)

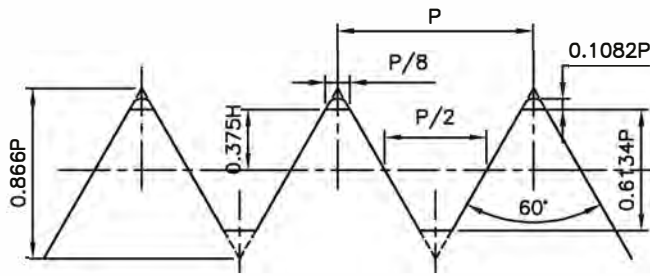

 Na sklade Na objednávku

Size						
			Go & Nogo Plug		Go & Nogo Plug	
Diameter	TPI	Catalogue Code	2B RH	3B RH	2B LH	3B LH
			2B DR	3B DR	2B DL	3B DL
No. 1	64	P NC NO001 064	✓	✓	○	○
No. 2	56	P NC NO002 056	✓	✓	○	○
No. 3	48	P NC NO003 048	✓	✓	○	○
No. 4	40	P NC NO004 040	✓	✓	✓	✓
No. 5	40	P NC NO005 040	✓	✓	✓	✓
No. 6	32	P NC NO006 032	✓	✓	✓	✓
No. 8	32	P NC NO008 032	✓	✓	✓	✓
No. 10	24	P NC NO010 024	✓	✓	✓	✓
No. 12	24	P NC NO012 024	✓	✓	✓	✓
¼	20	P NC 00104 020	✓	✓	✓	✓
5/16	18	P NC 00516 018	✓	✓	✓	✓
3/8	16	P NC 00308 016	✓	✓	✓	✓
7/16	14	P NC 00716 014	✓	✓	✓	✓
½	13	P NC 00102 013	✓	✓	✓	✓
9/16	12	P NC 00916 012	✓	✓	✓	✓
5/8	11	P NC 00508 011	✓	✓	✓	✓
¾	10	P NC 00304 010	✓	✓	✓	✓
7/8	9	P NC 00708 009	✓	✓	✓	✓
1	8	P NC 00100 008	✓	✓	✓	✓
1-1/8	7	P NC 00118 007	✓	✓	○	○
1-1/4	7	P NC 00114 007	✓	✓	○	○
1-3/8	6	P NC 00138 006	✓	✓	○	○
1-1/2	6	P NC 00112 006	✓	✓	○	○

 1B tolerance is in our manufacturing program. **PRICES ON REQUEST**

Specification: **ASME B1.2**

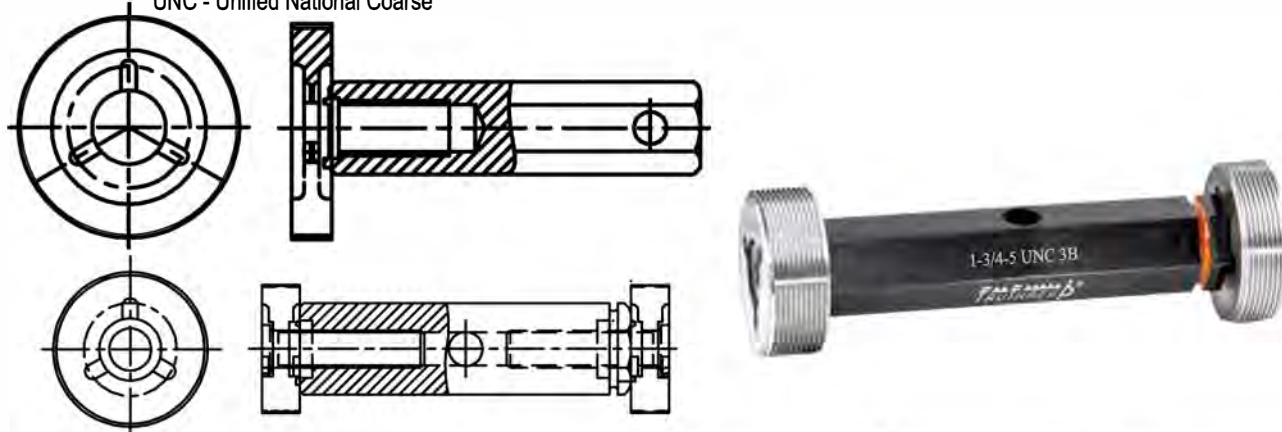
UNC - Unified National Coarse



✓ Na sklade ○ Na objednávku

Size		Catalogue Code	Right Hand				Left Hand			
Diameter	TPI		Go Plug 2B RH	Nogo Plug 2B RH	Go Plug 3B RH	Nogo Plug 3B RH	Go Plug 2B LH	Nogo Plug 2B LH	Go Plug 3B LH	Nogo Plug 3B LH
			2B GR	2B NR	3B GR	3B NR	2B GL	2B NL	3B GL	3B NL
1-3/4	5	P NC 00134 005	✓	✓	✓	✓	○	○	○	○
2	4.5	P NC 00200 045	✓	✓	✓	✓	○	○	○	○
2-1/4	4.5	P NC 00214 045	○	○	○	○	○	○	○	○
2-1/2	4	P NC 00212 004	○	○	○	○	○	○	○	○
2-3/4	4	P NC 00234 004	○	○	○	○	○	○	○	○
3	4	P NC 00300 004	○	○	○	○	○	○	○	○
3-1/4	4	P NC 00314 004	○	○	○	○	○	○	○	○
3-1/2	4	P NC 00312 004	○	○	○	○	○	○	○	○
3-3/4	4	P NC 00334 004	○	○	○	○	○	○	○	○
4	4	P NC 00400 004	○	○	○	○	○	○	○	○

1B tolerance is in our manufacturing program. PRICES ON REQUEST



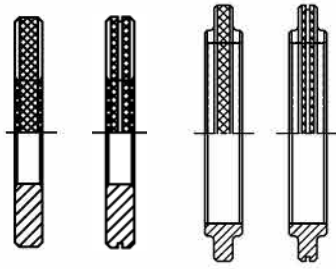

✓ Na sklade ○ Na objednávku

1A tolerance is in our manufacturing program. **PRICES ON REQUEST**

Size		Catalogue Code	Right Hand (RH)				Left Hand (LH)			
Diameter	TPI		Go Ring 2A RH	Nogo Ring 2A RH	Go Ring 3A RH	Nogo Ring 3A RH	Go Ring 2A LH	Nogo Ring 2A LH	Go Ring 3A LH	Nogo Ring 3A LH
			2A GR	2A NR	3A GR	3A NR	2A GL	2A NL	3A GL	3A NL
No. 4	40	R NC NO004 040	✓	✓	✓	✓	✓	✓	✓	✓
No. 5	40	R NC NO005 040	✓	✓	✓	✓	✓	✓	✓	✓
No. 6	32	R NC NO006 032	✓	✓	✓	✓	✓	✓	✓	✓
No. 8	32	R NC NO008 032	✓	✓	✓	✓	✓	✓	✓	✓
No. 10	24	R NC NO010 024	✓	✓	✓	✓	✓	✓	✓	✓
No. 12	24	R NC NO012 024	✓	✓	✓	✓	✓	✓	✓	✓
¼	20	R NC 00104 020	✓	✓	✓	✓	✓	✓	✓	✓
5/16	18	R NC 00516 018	✓	✓	✓	✓	✓	✓	✓	✓
3/8	16	R NC 00308 016	✓	✓	✓	✓	✓	✓	✓	✓
7/16	14	R NC 00716 014	✓	✓	✓	✓	✓	✓	✓	✓
½	13	R NC 00102 013	✓	✓	✓	✓	✓	✓	✓	✓
9/16	12	R NC 00916 012	✓	✓	✓	✓	✓	✓	✓	✓
5/8	11	R NC 00508 011	✓	✓	✓	✓	✓	✓	✓	✓
¾	10	R NC 00304 010	✓	✓	✓	✓	✓	✓	✓	✓
7/8	9	R NC 00708 009	✓	✓	✓	✓	✓	✓	✓	✓
1	8	R NC 00100 008	✓	✓	✓	✓	✓	✓	✓	✓
1-1/8	7	R NC 00118 007	✓	✓	✓	✓	○	○	○	○
1-1/4	7	R NC 00114 007	✓	✓	✓	✓	○	○	○	○
1-3/8	6	R NC 00138 006	○	○	○	○	○	○	○	○
1-1/2	6	R NC 00112 006	○	○	○	○	○	○	○	○
1-3/4	5	R NC 00134 005	○	○	○	○	○	○	○	○
2	4.5	R NC 00200 045	○	○	○	○	○	○	○	○
2-1/4	4.5	R NC 00214 045	○	○	○	○	○	○	○	○
2-1/2	4	R NC 00212 004	○	○	○	○	○	○	○	○
2-3/4	4	R NC 00234 004	○	○	○	○	○	○	○	○
3	4	R NC 00300 004	○	○	○	○	○	○	○	○
3-1/4	4	R NC 00314 004	○	○	○	○	○	○	○	○
3-1/2	4	R NC 00312 004	○	○	○	○	○	○	○	○
3-3/4	4	R NC 00334 004	○	○	○	○	○	○	○	○
4	4	R NC 00400 004	○	○	○	○	○	○	○	○



Specification: **ASME B1.2**

UNF - Unified National Fine



✓ Na sklade

○ Na objednávku

Size		Catalogue Code				
Diameter	TPI		Go & Nogo Plug	Go & Nogo Plug	Go & Nogo Plug	Go & Nogo Plug
			2B RH	3B RH	2B LH	3B LH
			2B DR	3B DR	2B DL	3B DL
No. 0	80	P NF NO000 080	✓	✓	○	○
No. 1	72	P NF NO001 072	✓	✓	○	○
No. 2	64	P NF NO002 064	✓	✓	○	○
No. 3	56	P NF NO003 056	✓	✓	○	○
No. 4	48	P NF NO004 048	✓	✓	✓	✓
No. 5	44	P NF NO005 044	✓	✓	✓	✓
No. 6	40	P NF NO006 040	✓	✓	✓	✓
No. 8	36	P NF NO008 036	✓	✓	✓	✓
No. 10	32	P NF NO010 032	✓	✓	✓	✓
No. 12	28	P NF NO012 028	✓	✓	✓	✓
¼	28	P NF 00104 028	✓	✓	✓	✓
5/16	24	P NF 00516 024	✓	✓	✓	✓
3/8	24	P NF 00308 024	✓	✓	✓	✓
7/16	20	P NF 00716 020	✓	✓	✓	✓
½	20	P NF 00102 020	✓	✓	✓	✓
9/16	18	P NF 00916 018	✓	✓	✓	✓
5/8	18	P NF 00508 018	✓	✓	✓	✓
¾	16	P NF 00304 016	✓	✓	✓	✓
7/8	14	P NF 00708 014	✓	✓	✓	✓
1	12	P NF 00100 012	✓	✓	✓	✓
1-1/8	12	P NF 00118 012	✓	✓	✓	✓
1-1/4	12	P NF 00114 012	✓	✓	✓	✓
1-3/8	12	P NF 00138 012	✓	✓	✓	✓
1-1/2	12	P NF 00112 012	✓	✓	✓	✓



1B tolerance is in our manufacturing program. PRICES ON REQUEST

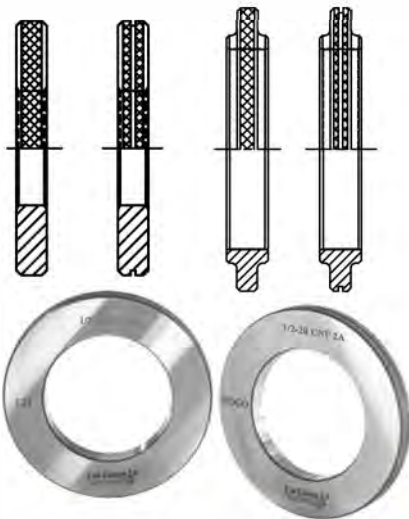

✓ Available in stock ○ Manufactured against order

1A tolerance is in our manufacturing program. **PRICES ON REQUEST**

Size		Catalogue Code	Right Hand (RH)				Left Hand (LH)			
Diameter	TPI		Go Ring 2A RH	Nogo Ring 2A RH	Go Ring 3A RH	Nogo Ring 3A RH	Go Ring 2A LH	Nogo Ring 2A LH	Go Ring 3A LH	Nogo Ring 3A LH
			2A GR	2A NR	3A GR	3A NR	2A GL	2A NL	3A GL	3A NL
No. 4	48	R NF NO004 048	✓	✓	✓	✓	○	○	○	○
No. 5	44	R NF NO005 044	✓	✓	✓	✓	✓	✓	○	○
No. 6	40	R NF NO006 040	✓	✓	✓	✓	✓	✓	○	○
No.8	36	R NF NO008 036	✓	✓	✓	✓	✓	✓	○	○
No. 10	32	R NF NO010 032	✓	✓	✓	✓	✓	✓	✓	✓
No. 12	28	R NF NO012 028	✓	✓	✓	✓	✓	✓	✓	✓
1/4	28	R NF 00104 028	✓	✓	✓	✓	✓	✓	✓	✓
5/16	24	R NF 00516 024	✓	✓	✓	✓	✓	✓	✓	✓
3/8	24	R NF 00308 024	✓	✓	✓	✓	✓	✓	✓	✓
7/16	20	R NF 00716 020	✓	✓	✓	✓	✓	✓	✓	✓
1/2	20	R NF 00102 020	✓	✓	✓	✓	✓	✓	✓	✓
9/16	18	R NF 00916 018	✓	✓	✓	✓	✓	✓	✓	✓
5/8	18	R NF 00508 018	✓	✓	✓	✓	✓	✓	✓	✓
3/4	16	R NF 00304 016	✓	✓	✓	✓	✓	✓	✓	✓
7/8	14	R NF 00708 014	✓	✓	✓	✓	✓	✓	✓	✓
1	12	R NF 00100 012	✓	✓	✓	✓	✓	✓	✓	✓
1-1/8	12	R NF 00118 012	✓	✓	✓	✓	○	○	○	○
1-1/4	12	R NF 00114 012	✓	✓	✓	✓	○	○	○	○
1-3/8	12	R NF 00138 012	✓	✓	✓	✓	○	○	○	○
1-1/2	12	R NF 00112 012	✓	✓	✓	✓	○	○	○	○





Specification: **ASME B1.2**

UNEF - Unified National Extra Fine



✓ Na sklade ○ Na objednávku

Size		Catalogue Code				
			Go & Nogo Plug	Go & Nogo Plug	Go & Nogo Plug	Go & Nogo Plug
Diameter	TPI		2B RH	3B RH	2B LH	3B LH
			2B DR	3B DR	2B DL	3B DL
No. 12	32	P NE NO012 032	✓	✓	✓	✓
1/4	32	P NE 00104 032	✓	✓	✓	✓
5/16	32	P NE 00516 032	✓	✓	✓	✓
3/8	32	P NE 00308 032	✓	✓	✓	✓
7/16	28	P NE 00716 028	✓	✓	✓	✓
1/2	28	P NE 00102 028	✓	✓	✓	✓
9/16	24	P NE 00916 024	✓	✓	✓	✓
5/8	24	P NE 00508 024	✓	✓	✓	✓
11/16	24	P NE 01116 024	✓	✓	✓	✓
3/4	20	P NE 00304 020	✓	✓	✓	✓
13/16	20	P NE 01316 020	✓	✓	✓	✓
7/8	20	P NE 00708 020	✓	✓	✓	✓
15/16	20	P NE 01516 020	✓	✓	✓	✓
1	20	P NE 00100 020	✓	✓	✓	✓
1-1/16	18	P NE 10116 018	✓	✓	○	○
1-1/8	18	P NE 00118 018	✓	✓	○	○
1-3/16	18	P NE 10316 018	✓	✓	○	○
1-1/4	18	P NE 00114 018	✓	✓	○	○
1-5/16	18	P NE 10516 018	✓	✓	○	○
1-3/8	18	P NE 00138 018	✓	✓		
1-7/16	18	P NE 10716 018	✓	✓		
1-1/2	18	P NE 00112 018	✓	○		
1-9/16	18	P NE 10916 018	✓	○		
1-5/8	18	P NE 00158 018	○	○		
1-11/16	18	P NE 11116 018	○	○		



1B tolerance is in our manufacturing program. PRICES ON REQUEST



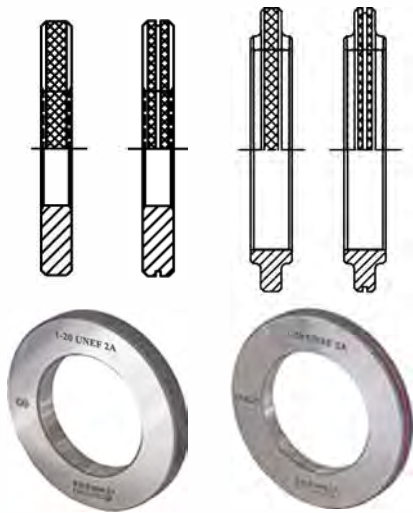

✓ Na sklade ○ Na objednávku

1A tolerance is in our manufacturing program. PRICES ON REQUEST

Size		Catalogue Code	Right Hand (RH)				Left Hand (LH)			
Diameter	TPI		Go Ring 2A RH	Nogo Ring 2A RH	Go Ring 3A RH	Nogo Ring 3A RH	Go Ring 2A LH	Nogo Ring 2A LH	Go Ring 3A LH	Nogo Ring 3A LH
			2A GR	2A NR	3A GR	3A NR	2A GL	2A NL	3A GL	3A NL
No. 12	32	R NE NO012 032	✓	✓	✓	✓	✓	✓	✓	✓
¼	32	R NE 00104 032	✓	✓	✓	✓	✓	✓	✓	✓
5/16	32	R NE 00516 032	✓	✓	✓	✓	✓	✓	✓	✓
3/8	32	R NE 00308 032	✓	✓	✓	✓	✓	✓	✓	✓
7/16	28	R NE 00716 028	✓	✓	✓	✓	✓	✓	✓	✓
½	28	R NE 00102 028	✓	✓	✓	✓	✓	✓	✓	✓
9/16	24	R NE 00916 024	✓	✓	✓	✓	✓	✓	✓	✓
5/8	24	R NE 00508 024	✓	✓	✓	✓	✓	✓	✓	✓
11/16	24	R NE 01116 024	✓	✓	✓	✓	○	○	○	○
¾	20	R NE 00304 020	✓	✓	✓	✓	✓	✓	✓	✓
13/16	20	R NE 01316 020	✓	✓	✓	✓	○	○	○	○
7/8	20	R NE 00708 020	✓	✓	✓	✓	✓	✓	✓	✓
15/16	20	R NE 01516 020	✓	✓	✓	✓	○	○	○	○
1	20	R NE 00100 020	✓	✓	✓	✓	✓	✓	✓	✓
1-1/16	18	R NE 10116 018	✓	✓	✓	✓	✓	✓	✓	✓
1-1/8	18	R NE 00118 018	✓	✓	✓	✓	✓	✓	✓	✓
1-3/16	18	R NE 10316 018	✓	✓	✓	✓	✓	✓	✓	✓
1-1/4	18	R NE 00114 018	✓	✓	✓	✓	✓	✓	✓	✓
1-5/16	18	R NE 10516 018	✓	✓	✓	✓	✓	✓	✓	✓
1-3/8	18	R NE 00138 018	✓	✓	✓	✓	✓	✓	✓	✓
1-7/16	18	R NE 10716 018	✓	✓	✓	✓	○	○	○	○
1-1/2	18	R NE 00112 018	✓	✓	✓	✓	✓	✓	✓	✓
1-9/16	18	R NE 10916 018	✓	✓	✓	✓	○	○	○	○
1-5/8	18	R NE 00158 018	✓	✓	✓	✓	○	○	○	○
1-11/16	18	R NE 11116 018	○	○	○	○	○	○	○	○





Specification: **ASME B1.2**

UN - Unified National Constant TPI



✓ Na sklade ○ Na objednávku

Size		Catalogue Code				
Diameter	TPI		Go & Nogo Plug	Go & Nogo Plug	Go & Nogo Plug	Go & Nogo Plug
			2B RH	3B RH	2B LH	3B LH
5/8	20	P UN 00508 020	✓	✓	✓	✓
3/4	12	P UN 00304 012	✓	✓	✓	✓
7/8	12	P UN 00708 012	✓	✓	✓	✓
	16	P UN 00708 016	✓	✓	✓	✓
1	16	P UN 00100 016	✓	✓	✓	✓
	28	P UN 00100 028	✓	✓	✓	✓
	32	P UN 00100 032	✓	✓	✓	✓
1-1/16	12	P UN 10116 012	✓	✓	✓	✓
1-1/8	8	P UN 00118 008	✓	✓	✓	✓
	16	P UN 00118 016	○	○	○	○
	20	P UN 00118 020	○	○	○	○
1-1/4	8	P UN 00114 008	✓	✓	✓	✓
	16	P UN 00114 016	○	○	○	○
	20	P UN 00114 020	○	○	○	○
1-3/8	8	P UN 00138 008	✓	✓	✓	✓
	16	P UN 00138 016	○	○	○	○
	20	P UN 00138 020	○	○	○	○
1-1/2	8	P UN 00112 008	✓	✓	✓	✓
	16	P UN 00112 016	✓	✓	✓	✓
	20	P UN 00112 020	✓	✓	✓	✓
1-5/8	8	P UN 00158 008	✓	✓	✓	✓
	12	P UN 00158 012	✓	✓	✓	✓
1-3/4	8	P UN 00134 008	✓	✓	✓	✓
	12	P UN 00134 012	✓	✓	✓	✓
	20	P UN 00134 020	○	○	○	○
1-7/8	8	P UN 00178 008	✓	✓	✓	✓
	12	P UN 00178 012	✓	✓	✓	✓
2	8	P UN 00200 008	✓	✓	✓	✓
	12	P UN 00200 012	✓	✓	✓	✓
2-1/8	6	P UN 00218 006	○	○	○	○
	8	P UN 00218 008	✓	✓	✓	✓
	12	P UN 00218 012	✓	✓	✓	✓
2-1/4	8	P UN 00214 008	✓	✓	✓	✓
	12	P UN 00214 012	✓	✓	✓	✓
2-3/8	8	P UN 00238 008	✓	✓	✓	✓
	12	P UN 00238 012	✓	✓	✓	✓
2-1/2	8	P UN 00212 008	✓	✓	✓	✓
	12	P UN 00212 012	✓	✓	✓	✓



The Sizes & tolerances not covered in catalogue are in our manufacturing program. PRICES ON REQUEST

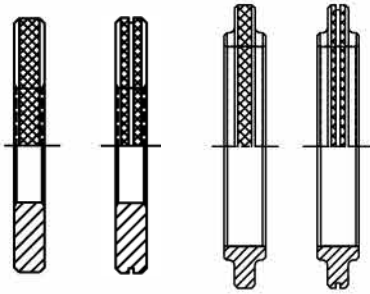

✓ Na sklade ○ Na objednávku

The Sizes & tolerances not covered in catalogue are in our manufacturing program. **PRICES ON REQUEST**

Size			↻				↻			
			Go Ring 2A RH	Nogo Ring 2A RH	Go Ring 3A RH	Nogo Ring 3A RH	Go Ring 2A LH	Nogo Ring 2A LH	Go Ring 3A LH	Nogo Ring 3A LH
Diameter	TPI	Catalogue Code	2A GR	2A NR	3A GR	3A NR	2A GL	2A NL	3A GL	3A NL
5/8	20	R UN 00508 020	✓	✓	○	○	○	○	○	○
3/4	12	R UN 00304 012	✓	✓	○	○	○	○	○	○
7/8	12	R UN 00708 012	✓	✓	○	○	○	○	○	○
	16	R UN 00708 016	✓	✓	○	○	○	○	○	○
1	16	R UN 00100 016	✓	✓	✓	✓	○	○	○	○
	28	R UN 00100 028	✓	✓	✓	✓	○	○	○	○
	32	R UN 00100 032	✓	✓	○	○	○	○	○	○
1-1/16	12	R UN 10116 012	✓	✓	○	○	○	○	○	○
1-1/8	8	R UN 00118 008	✓	✓	✓	✓	○	○	○	○
	16	R UN 00118 016	✓	✓	✓	✓	○	○	○	○
	20	R UN 00118 020	✓	✓	○	○	○	○	○	○
1-1/4	8	R UN 00114 008	✓	✓	✓	✓	○	○	○	○
	16	R UN 00114 016	✓	✓	✓	✓	○	○	○	○
	20	R UN 00114 020	✓	✓	✓	✓	○	○	○	○
1-3/8	8	R UN 00138 008	✓	✓	✓	✓	○	○	○	○
	16	R UN 00138 016	✓	✓	○	○	○	○	○	○
	20	R UN 00138 020	✓	✓	○	○	○	○	○	○
1-1/2	8	R UN 00112 008	✓	✓	✓	✓	○	○	○	○
	16	R UN 00112 016	✓	✓	○	○	○	○	○	○
	20	R UN 00112 020	✓	✓	○	○	○	○	○	○
1-5/8	8	R UN 00158 008	✓	✓	○	○	○	○	○	○
	12	R UN 00158 012	✓	✓	○	○	○	○	○	○
1-3/4	8	R UN 00134 008	✓	✓	✓	✓	○	○	○	○
	12	R UN 00134 012	✓	✓	✓	✓	○	○	○	○
	20	R UN 00134 020	✓	✓	○	○	○	○	○	○
1-7/8	8	R UN 00178 008	✓	✓	○	○	○	○	○	○
	12	R UN 00178 012	✓	✓	○	○	○	○	○	○
2	8	R UN 00200 008	✓	✓	✓	✓	○	○	○	○
	12	R UN 00200 012	✓	✓	○	○	○	○	○	○
2-1/8	6	R UN 00218 006	✓	✓	○	○	○	○	○	○
	8	R UN 00218 008	✓	✓	✓	✓	○	○	○	○
	12	R UN 00218 012	✓	✓	○	○	○	○	○	○
2-1/4	8	R UN 00214 008	✓	✓	✓	✓	○	○	○	○
	12	R UN 00214 012	✓	✓	✓	✓	○	○	○	○
2-3/8	8	R UN 00238 008	✓	✓	○	○	○	○	○	○
	12	R UN 00238 012	✓	✓	○	○	○	○	○	○
2-1/2	8	R UN 00212 008	✓	✓	✓	✓	○	○	○	○
	12	R UN 00212 012	✓	✓	✓	✓	○	○	○	○





Specification: **ASME B1.2**

UN - Unified National Constant TPI

 Na sklade Na objednávku

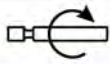
 The Sizes & tolerances not cover red in catalogue are in our manufacturing program. **PRICES ON REQUEST**

Size		Catalogue Code								
Diameter	TPI		Go Plug	Nogo Plug	Go Plug	Nogo Plug	Go Plug	Nogo Plug	Go Plug	Nogo Plug
			2B RH	2B RH	3B RH	3B RH	2B LH	2B LH	3B LH	3B LH
2-5/8	8	P UN 00258 008	<input type="radio"/>	<input type="radio"/>	<input type="radio"/>	<input type="radio"/>	<input type="radio"/>	<input type="radio"/>	<input type="radio"/>	<input type="radio"/>
	12	P UN 00258 012	<input type="radio"/>	<input type="radio"/>	<input type="radio"/>	<input type="radio"/>	<input type="radio"/>	<input type="radio"/>	<input type="radio"/>	<input type="radio"/>
	16	P UN 00258 016	<input type="radio"/>	<input type="radio"/>	<input type="radio"/>	<input type="radio"/>	<input type="radio"/>	<input type="radio"/>	<input type="radio"/>	<input type="radio"/>
2-3/4	8	P UN 00234 008	<input checked="" type="radio"/>	<input checked="" type="radio"/>	<input type="radio"/>	<input type="radio"/>	<input type="radio"/>	<input type="radio"/>	<input type="radio"/>	<input type="radio"/>
	12	P UN 00234 012	<input checked="" type="radio"/>	<input checked="" type="radio"/>	<input type="radio"/>	<input type="radio"/>	<input type="radio"/>	<input type="radio"/>	<input type="radio"/>	<input type="radio"/>
	16	P UN 00234 016	<input type="radio"/>	<input type="radio"/>	<input type="radio"/>	<input type="radio"/>	<input type="radio"/>	<input type="radio"/>	<input type="radio"/>	<input type="radio"/>
2-7/8	8	P UN 00278 008	<input type="radio"/>	<input type="radio"/>	<input type="radio"/>	<input type="radio"/>	<input type="radio"/>	<input type="radio"/>	<input type="radio"/>	<input type="radio"/>
	12	P UN 00278 012	<input type="radio"/>	<input type="radio"/>	<input type="radio"/>	<input type="radio"/>	<input type="radio"/>	<input type="radio"/>	<input type="radio"/>	<input type="radio"/>
	16	P UN 00278 016	<input type="radio"/>	<input type="radio"/>	<input type="radio"/>	<input type="radio"/>	<input type="radio"/>	<input type="radio"/>	<input type="radio"/>	<input type="radio"/>
3	8	P UN 00300 008	<input checked="" type="radio"/>	<input checked="" type="radio"/>	<input type="radio"/>	<input type="radio"/>	<input type="radio"/>	<input type="radio"/>	<input type="radio"/>	<input type="radio"/>
	12	P UN 00300 012	<input checked="" type="radio"/>	<input checked="" type="radio"/>	<input type="radio"/>	<input type="radio"/>	<input type="radio"/>	<input type="radio"/>	<input type="radio"/>	<input type="radio"/>
	16	P UN 00300 016	<input type="radio"/>	<input type="radio"/>	<input type="radio"/>	<input type="radio"/>	<input type="radio"/>	<input type="radio"/>	<input type="radio"/>	<input type="radio"/>
3-1/8	8	P UN 00318 008	<input checked="" type="radio"/>	<input checked="" type="radio"/>	<input type="radio"/>	<input type="radio"/>	<input type="radio"/>	<input type="radio"/>	<input type="radio"/>	<input type="radio"/>
	12	P UN 00318 012	<input type="radio"/>	<input type="radio"/>	<input type="radio"/>	<input type="radio"/>	<input type="radio"/>	<input type="radio"/>	<input type="radio"/>	<input type="radio"/>
	16	P UN 00318 016	<input type="radio"/>	<input type="radio"/>	<input type="radio"/>	<input type="radio"/>	<input type="radio"/>	<input type="radio"/>	<input type="radio"/>	<input type="radio"/>
3-1/4	8	P UN 00314 008	<input checked="" type="radio"/>	<input checked="" type="radio"/>	<input type="radio"/>	<input type="radio"/>	<input type="radio"/>	<input type="radio"/>	<input type="radio"/>	<input type="radio"/>
	12	P UN 00314 012	<input type="radio"/>	<input type="radio"/>	<input type="radio"/>	<input type="radio"/>	<input type="radio"/>	<input type="radio"/>	<input type="radio"/>	<input type="radio"/>
	16	P UN 00314 016	<input type="radio"/>	<input type="radio"/>	<input type="radio"/>	<input type="radio"/>	<input type="radio"/>	<input type="radio"/>	<input type="radio"/>	<input type="radio"/>
3-1/2	8	P UN 00312 008	<input checked="" type="radio"/>	<input checked="" type="radio"/>	<input type="radio"/>	<input type="radio"/>	<input type="radio"/>	<input type="radio"/>	<input type="radio"/>	<input type="radio"/>
	12	P UN 00312 012	<input checked="" type="radio"/>	<input checked="" type="radio"/>	<input type="radio"/>	<input type="radio"/>	<input type="radio"/>	<input type="radio"/>	<input type="radio"/>	<input type="radio"/>
	16	P UN 00312 016	<input type="radio"/>	<input type="radio"/>	<input type="radio"/>	<input type="radio"/>	<input type="radio"/>	<input type="radio"/>	<input type="radio"/>	<input type="radio"/>
3-3/4	8	P UN 00334 008	<input checked="" type="radio"/>	<input checked="" type="radio"/>	<input type="radio"/>	<input type="radio"/>	<input type="radio"/>	<input type="radio"/>	<input type="radio"/>	<input type="radio"/>
	12	P UN 00334 012	<input checked="" type="radio"/>	<input checked="" type="radio"/>	<input type="radio"/>	<input type="radio"/>	<input type="radio"/>	<input type="radio"/>	<input type="radio"/>	<input type="radio"/>
	16	P UN 00334 016	<input type="radio"/>	<input type="radio"/>	<input type="radio"/>	<input type="radio"/>	<input type="radio"/>	<input type="radio"/>	<input type="radio"/>	<input type="radio"/>
4	8	P UN 00400 008	<input type="radio"/>	<input type="radio"/>	<input type="radio"/>	<input type="radio"/>	<input type="radio"/>	<input type="radio"/>	<input type="radio"/>	<input type="radio"/>
	12	P UN 00400 012	<input type="radio"/>	<input type="radio"/>	<input type="radio"/>	<input type="radio"/>	<input type="radio"/>	<input type="radio"/>	<input type="radio"/>	<input type="radio"/>
	16	P UN 00400 016	<input type="radio"/>	<input type="radio"/>	<input type="radio"/>	<input type="radio"/>	<input type="radio"/>	<input type="radio"/>	<input type="radio"/>	<input type="radio"/>

Náš výrobný program zahŕňa -

- Závitové trne s Toleranciou triedy **1B**
- UNS (UNIFIED NATIONAL SPECIAL) závitové série s Dia.- TPI kombináciou nie sú zahrnuté v katalógu.
- Závitové kalibre s veľkosťou nad 4 Inch do 14 Inch

CENY NA VYŽIADANIE.

Specification: **ASME B1.2**

UN - Unified National Constant TPI

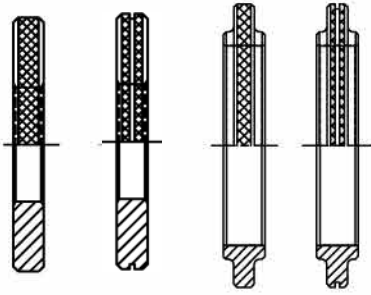

The Sizes & tolerances not covered in catalogue are in our manufacturing program. **PRICES ON REQUEST**

			↻				↻			
✓ Na sklade		○ Na objednávku	Go Ring	Nogo Ring	Go Ring	Nogo Ring	Go Ring	Nogo Ring	Go Ring	Nogo Ring
Size		Catalogue Code	2A RH	2A RH	3A RH	3A RH	2A LH	2A LH	3A LH	3A LH
Diameter	TPI		2A GR	2A NR	3A GR	3A NR	2A GL	2A NL	3A GL	3A NL
2-5/8	8	R UN 00258 008	○	○	○	○	○	○	○	○
	12	R UN 00258 012	○	○	○	○	○	○	○	○
	16	R UN 00258 016	○	○	○	○	○	○	○	○
2-3/4	8	R UN 00234 008	○	○	○	○	○	○	○	○
	12	R UN 00234 012	○	○	○	○	○	○	○	○
	16	R UN 00234 016	○	○	○	○	○	○	○	○
2-7/8	8	R UN 00278 008	○	○	○	○	○	○	○	○
	12	R UN 00278 012	○	○	○	○	○	○	○	○
	16	R UN 00278 016	○	○	○	○	○	○	○	○
3	8	R UN 00300 008	○	○	○	○	○	○	○	○
	12	R UN 00300 012	○	○	○	○	○	○	○	○
	16	R UN 00300 016	○	○	○	○	○	○	○	○
3-1/8	8	R UN 00318 008	○	○	○	○	○	○	○	○
	12	R UN 00318 012	○	○	○	○	○	○	○	○
	16	R UN 00318 016	○	○	○	○	○	○	○	○
3-1/4	8	R UN 00314 008	○	○	○	○	○	○	○	○
	12	R UN 00314 012	○	○	○	○	○	○	○	○
	16	R UN 00314 016	○	○	○	○	○	○	○	○
3-1/2	8	R UN 00312 008	○	○	○	○	○	○	○	○
	12	R UN 00312 012	○	○	○	○	○	○	○	○
	16	R UN 00312 016	○	○	○	○	○	○	○	○
3-3/4	8	R UN 00334 008	○	○	○	○	○	○	○	○
	12	R UN 00334 012	○	○	○	○	○	○	○	○
	16	R UN 00334 016	○	○	○	○	○	○	○	○
4	8	R UN 00400 008	○	○	○	○	○	○	○	○
	12	R UN 00400 012	○	○	○	○	○	○	○	○
	16	R UN 00400 016	○	○	○	○	○	○	○	○

Náš výrobný program zahŕňa

- Záv. krúžky s Toleranciou triedy **1A**
- **UNS (UNIFIED NATIONAL SPECIAL)** Závity série s Dia. - TPI kombináciou nie sú zahrnuté v katalogu.
- Závité kalibre s veľkosťou nad 4 inch do 14 inch

CENY NA VYŽIADANIE

Specification: **ASME B1.15**
ISO 3161/BS 4084

Application : Used in Aeronautical industry
for Imperial system of units.

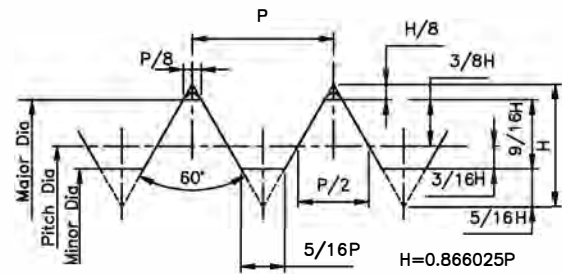

panas

The Tolerances not covered in catalogue are in our manufacturing program. **PRICES ON REQUEST**

Na sklade Na objednávku

Size		Catalogue Code	Go & Nogo Plug	
Diameter	TPI		3B RH	3B DR
No. 4	40	P JC NO004 040	<input checked="" type="checkbox"/>	<input checked="" type="checkbox"/>
No. 5	40	P JC NO005 040	<input checked="" type="checkbox"/>	<input checked="" type="checkbox"/>
No. 6	32	P JC NO006 032	<input checked="" type="checkbox"/>	<input checked="" type="checkbox"/>
No. 8	32	P JC NO008 032	<input checked="" type="checkbox"/>	<input checked="" type="checkbox"/>
No. 10	24	P JC NO010 024	<input checked="" type="checkbox"/>	<input checked="" type="checkbox"/>
No. 12	24	P JC NO012 024	<input checked="" type="checkbox"/>	<input checked="" type="checkbox"/>
1/4	20	P JC 00104 020	<input checked="" type="checkbox"/>	<input checked="" type="checkbox"/>
5/16	18	P JC 00516 018	<input checked="" type="checkbox"/>	<input checked="" type="checkbox"/>
3/8	16	P JC 00308 016	<input checked="" type="checkbox"/>	<input checked="" type="checkbox"/>
7/16	14	P JC 00716 014	<input checked="" type="checkbox"/>	<input checked="" type="checkbox"/>
1/2	13	P JC 00102 013	<input checked="" type="checkbox"/>	<input checked="" type="checkbox"/>
9/16	12	P JC 00916 012	<input checked="" type="checkbox"/>	<input checked="" type="checkbox"/>
5/8	11	P JC 00508 011	<input checked="" type="checkbox"/>	<input checked="" type="checkbox"/>
3/4	10	P JC 00304 010	<input checked="" type="checkbox"/>	<input checked="" type="checkbox"/>
7/8	9	P JC 00708 009	<input checked="" type="checkbox"/>	<input checked="" type="checkbox"/>
1	8	P JC 00100 008	<input checked="" type="checkbox"/>	<input checked="" type="checkbox"/>



Size		Catalogue Code	Go Ring		Nogo Ring	
Diameter	TPI		3A RH	3A RH	3A GR	3A NR
No. 4	40	R JC NO004 040	<input checked="" type="checkbox"/>	<input checked="" type="checkbox"/>	<input checked="" type="checkbox"/>	<input checked="" type="checkbox"/>
No. 5	40	R JC NO005 040	<input checked="" type="checkbox"/>	<input checked="" type="checkbox"/>	<input checked="" type="checkbox"/>	<input checked="" type="checkbox"/>
No. 6	32	R JC NO006 032	<input checked="" type="checkbox"/>	<input checked="" type="checkbox"/>	<input checked="" type="checkbox"/>	<input checked="" type="checkbox"/>
No. 8	32	R JC NO008 032	<input checked="" type="checkbox"/>	<input checked="" type="checkbox"/>	<input checked="" type="checkbox"/>	<input checked="" type="checkbox"/>
No. 10	24	R JC NO010 024	<input checked="" type="checkbox"/>	<input checked="" type="checkbox"/>	<input checked="" type="checkbox"/>	<input checked="" type="checkbox"/>
No. 12	24	R JC NO012 024	<input checked="" type="checkbox"/>	<input checked="" type="checkbox"/>	<input checked="" type="checkbox"/>	<input checked="" type="checkbox"/>
1/4	20	R JC 00104 020	<input checked="" type="checkbox"/>	<input checked="" type="checkbox"/>	<input checked="" type="checkbox"/>	<input checked="" type="checkbox"/>
5/16	18	R JC 00516 018	<input checked="" type="checkbox"/>	<input checked="" type="checkbox"/>	<input checked="" type="checkbox"/>	<input checked="" type="checkbox"/>
3/8	16	R JC 00308 016	<input checked="" type="checkbox"/>	<input checked="" type="checkbox"/>	<input checked="" type="checkbox"/>	<input checked="" type="checkbox"/>
7/16	14	R JC 00716 014	<input checked="" type="checkbox"/>	<input checked="" type="checkbox"/>	<input checked="" type="checkbox"/>	<input checked="" type="checkbox"/>
1/2	13	R JC 00102 013	<input checked="" type="checkbox"/>	<input checked="" type="checkbox"/>	<input checked="" type="checkbox"/>	<input checked="" type="checkbox"/>
9/16	12	R JC 00916 012	<input checked="" type="checkbox"/>	<input checked="" type="checkbox"/>	<input checked="" type="checkbox"/>	<input checked="" type="checkbox"/>
5/8	11	R JC 00508 011	<input checked="" type="checkbox"/>	<input checked="" type="checkbox"/>	<input checked="" type="checkbox"/>	<input checked="" type="checkbox"/>
3/4	10	R JC 00304 010	<input checked="" type="checkbox"/>	<input checked="" type="checkbox"/>	<input checked="" type="checkbox"/>	<input checked="" type="checkbox"/>
7/8	9	R JC 00708 009	<input checked="" type="checkbox"/>	<input checked="" type="checkbox"/>	<input checked="" type="checkbox"/>	<input checked="" type="checkbox"/>
1	8	R JC 00100 008	<input checked="" type="checkbox"/>	<input checked="" type="checkbox"/>	<input checked="" type="checkbox"/>	<input checked="" type="checkbox"/>





Go & Nogo Plug

3B RH

✓ Na sklade ○ Na objednávku

Size		Catalogue Code	3B RH
Diameter	TPI		3B DR
No. 4	48	P JF NO004 048	✓
No. 5	44	P JF NO005 044	✓
No. 6	40	P JF NO006 040	✓
No. 8	36	P JF NO008 036	✓
No. 10	32	P JF NO010 032	✓
No. 12	28	P JF NO012 028	✓
1/4	28	P JF 00104 028	✓
5/16	24	P JF 00516 024	✓
3/8	24	P JF 00308 024	✓
7/16	20	P JF 00716 020	✓
1/2	20	P JF 00102 020	✓
9/16	18	P JF 00916 018	✓
5/8	18	P JF 00508 018	✓
3/4	16	P JF 00304 016	✓
7/8	14	P JF 00708 014	✓
1	12	P JF 00100 012	✓

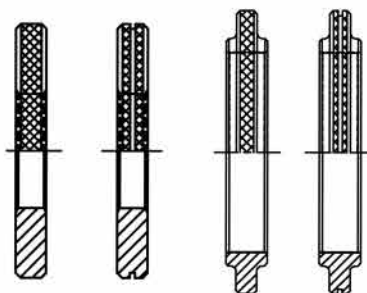

Go Ring

Nogo Ring

Size		Catalogue Code	3A RH	3A RH
Diameter	TPI		3A GR	3A NR
No. 4	48	R JF NO004 048	✓	✓
No. 5	44	R JF NO005 044	✓	✓
No. 6	40	R JF NO006 040	✓	✓
No. 8	36	R JF NO008 036	✓	✓
No. 10	32	R JF NO010 032	✓	✓
No. 12	28	R JF NO012 028	✓	✓
1/4	28	R JF 00104 028	✓	✓
5/16	24	R JF 00516 024	✓	✓
3/8	24	R JF 00308 024	✓	✓
7/16	20	R JF 00716 020	✓	✓
1/2	20	R JF 00102 020	✓	✓
9/16	18	R JF 00916 018	✓	✓
5/8	18	R JF 00508 018	✓	✓
3/4	16	R JF 00304 016	✓	✓
7/8	14	R JF 00708 014	✓	✓
1	12	R JF 00100 012	✓	✓



The Tolerances not covered in catalogue are in our manufacturing program. **PRICES ON REQUEST**



Size		Catalogue Code	Go & Nogo Plug	
Diameter	TPI		3B RH	3B DR
No. 12	32	P JE NO012 032	✓	✓
1/4	32	P JE 00104 032	✓	✓
5/16	32	P JE 00516 032	✓	✓
3/8	32	P JE 00308 032	✓	✓
7/16	28	P JE 00716 028	✓	✓
1/2	28	P JE 00102 028	✓	✓
9/16	24	P JE 00916 024	✓	✓
5/8	24	P JE 00508 024	✓	✓
11/16	24	P JE 01116 024	○	○
3/4	20	P JE 00304 020	○	○
13/16	20	P JE 01316 020	○	○
7/8	20	P JE 00708 020	○	○
15/16	20	P JE 01516 020	○	○
1	20	P JE 00100 020	○	○

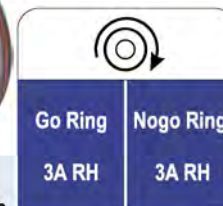
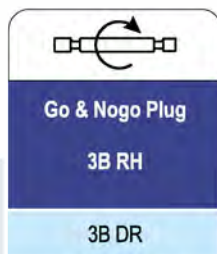

Size		Catalogue Code	Go Ring		Nogo Ring	
Diameter	TPI		3A RH	3A RH	3A GR	3A NR
No. 12	32	R JE NO012 032	✓	✓	✓	✓
1/4	32	R JE 00104 032	✓	✓	✓	✓
5/16	32	R JE 00516 032	✓	✓	✓	✓
3/8	32	R JE 00308 032	✓	✓	✓	✓
7/16	28	R JE 00716 028	✓	✓	✓	✓
1/2	28	R JE 00102 028	✓	✓	✓	✓
9/16	24	R JE 00916 024	○	○	○	○
5/8	24	R JE 00508 024	○	○	○	○
11/16	24	R JE 01116 024	○	○	○	○
3/4	20	R JE 00304 020	○	○	○	○
13/16	20	R JE 01316 020	○	○	○	○
7/8	20	R JE 00708 020	○	○	○	○
15/16	20	R JE 01516 020	○	○	○	○
1	20	R JE 00100 020	○	○	○	○

UNJ TRN / KRÚŽOK

Size		Catalogue Code	Go & Nogo Plug	
Diameter	TPI		3B RH	3B DR
9/16	20	P JN 00916 020	✓	✓
5/8	20	P JN 00508 020	✓	✓
3/4	12	P JN 00304 012	✓	✓
13/16	12	P JN 01316 012	○	○
	16	P JN 01316 016	○	○
7/8	12	P JN 00708 012	✓	✓
	16	P JN 00708 016	✓	✓
15/16	12	P JN 01516 012	○	○
	16	P JN 01516 016	○	○
1	16	P JN 00100 016	○	○

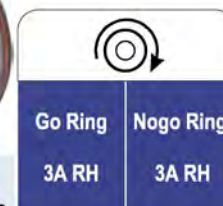

Size		Catalogue Code	Go Ring		Nogo Ring	
Diameter	TPI		3A RH	3A RH	3A GR	3A NR
9/16	20	R JN 00916 020	✓	✓	✓	✓
5/8	20	R JN 00508 020	✓	✓	✓	✓
3/4	12	R JN 00304 012	✓	✓	✓	✓
13/16	12	R JN 01316 012	○	○	○	○
	16	R JN 01316 016	○	○	○	○
7/8	12	R JN 00708 012	✓	✓	✓	✓
	16	R JN 00708 016	✓	✓	✓	✓
15/16	12	R JN 01516 012	○	○	○	○
	16	R JN 01516 016	○	○	○	○
1	16	R JN 00100 016	○	○	○	○

The Tolerances not covered in catalogue are in our manufacturing program. PRICES ON REQUEST



UNC & UNF

Application: To check tapped holes to receive wire thread inserts.



These gauges are used for checking oversize tapping which is done for fitting wire thread inserts. Wire thread inserts are having external threads which are oversize than the standard size and internal threads which are of standard dimensions. When tapped internal threads become oversize and standard screw cannot be fitted then wire threads inserts are used. Oversize tapping is done using wire thread taps and wire thread inserts are fitted in this.

• These are also known as Heli-coil thread inserts. 'Heli-coil' is a registered Trade mark of Emhart Technologies, USA.

TOLERANCE CLASS : 2B & 3B classes are recommended for Unified threads.

 Na sklade

 Na objednávku

Size		Catalogue Code					
Diameter	TPI		Go & Nogo Plug 2B RH	Go & Nogo Plug 3B RH	Go & Nogo Plug 2B LH	Go & Nogo Plug 3B LH	
			2B DR	3B DR	2B DL	3B DL	
No. 4	40	UNC	P CS NO004 040	✓	✓	✓	○
No. 5	40	UNC	P CS NO005 040	✓	✓	✓	○
No. 6	32	UNC	P CS NO006 032	✓	✓	✓	○
No. 8	32	UNC	P CS NO008 032	✓	✓	✓	○
No. 10	24	UNC	P CS NO010 024	✓	✓	✓	○
No. 12	24	UNC	P CS NO012 024	✓	✓	✓	○
1/4	20	UNC	P CS 00104 020	✓	✓	✓	○
5/16	18	UNC	P CS 00516 018	✓	✓	✓	○
3/8	16	UNC	P CS 00308 016	✓	✓	✓	○
7/16	14	UNC	P CS 00716 014	✓	✓	✓	○
1/2	13	UNC	P CS 00102 013	✓	✓	✓	○
9/16	12	UNC	P CS 00916 012	✓	✓	✓	○
5/8	11	UNC	P CS 00508 011	✓	✓	✓	○
3/4	10	UNC	P CS 00304 010	✓	✓	✓	○
7/8	9	UNC	P CS 00708 009	✓	✓	✓	○
1	8	UNC	P CS 00100 008	✓	✓	✓	○
No.4	48	UNF	P FS NO004 048	✓	✓	✓	○
No.5	44	UNF	P FS NO005 044	✓	✓	✓	○
No.6	40	UNF	P FS NO006 040	✓	✓	✓	○
No.8	36	UNF	P FS NO008 036	✓	✓	✓	○
No.10	32	UNF	P FS NO010 032	✓	✓	✓	○
No.12	28	UNF	P FS NO012 028	✓	✓	✓	○
1/4	28	UNF	P FS 00104 028	✓	✓	✓	○
5/16	24	UNF	P FS 00516 024	✓	✓	✓	○
3/8	24	UNF	P FS 00308 024	✓	✓	✓	○
7/16	20	UNF	P FS 00716 020	✓	✓	✓	○
1/2	20	UNF	P FS 00102 020	✓	✓	✓	○
9/16	18	UNF	P FS 00916 018	✓	✓	✓	○
5/8	18	UNF	P FS 00508 018	✓	✓	✓	○
3/4	16	UNF	P FS 00304 016	✓	✓	✓	○
7/8	14	UNF	P FS 00708 014	✓	✓	✓	○
1	12	UNF	P FS 00100 012	✓	✓	✓	○

 The Sizes not covered in catalogue are in our manufacturing program. **PRICES ON REQUEST**